

**CHLORIDE HISTORY AND
TRENDS OF WATER
PRODUCTION WELLS IN
THE NORTHERN GUAM
LENS AQUIFER**

Mauryn Q. McDonald

John W. Jenson

WERI

**WATER AND ENVIRONMENTAL RESEARCH INSTITUTE
OF THE WESTERN PACIFIC
UNIVERSITY OF GUAM**

Technical Report No. 98

March 2003

Chloride History and Trends of Water Production Wells in the Northern Guam Lens Aquifer

**Mauryn Q. McDonald
&
John W. Jenson**

Technical Report No. 98

**Water & Environmental Research Institute
Of the Western Pacific
University of Guam**

March 31, 2003

**This study was conducted under the Guam Hydrologic
Survey and was funded by the 25th and 26th Guam
Legislatures**

ABSTRACT

The Northern Guam Lens Aquifer is an island karst aquifer in uplifted Plio-Pleistocene limestone supported by early Tertiary volcanic basement rock. The limestone surface forms a plateau 200 to 600 ft (60 to 180 m) above sea level and occupying about half of the island's 212 mi² (550 km²). The relatively impermeable basement rises above sea level beneath about 20% of the limestone plateau but protrudes above only about 1% of the plateau surface. Groundwater descending from the surface is shunted into six subbasins by the subterranean topographic divides in the basement rock. Regional aquifer hydraulic conductivity estimated from modeling studies is about 6,000 m/day. Estimated total sustainable yield is 70 to 80 mgd (265,000 to 300,000 m³/day). Total production in 1999 was about 40 mgd (150,000 m³/day). Pumping rates at the 126 extant wells then on-line ranged to 600 gpm (40 l/sec), with 200 gpm (13 l/sec) being typical. Aquifer production accounts for about 80% of the potable water for the island's 130,000 permanent residents and more than 1 million tourists that visit the island annually. Reliable production records begin in 1980. Records of chloride ion concentration begin in 1973.

Previous studies have shown that where the freshwater lens laps onto the flank of the basement rock, the natural background chloride is typically less than 30 mg/l. Where the lens transitions to being supported by seawater, chloride typically ranges up to about 70 mg/l. Seaward, where the lens is underlain entirely by saltwater, fresh water with less than 150 mg/l chloride can usually be extracted by properly constructed wells. These values therefore provide useful benchmarks by which to predict, evaluate, and manage the performance of wells in the respective zones. Linear regression of the average quarterly chloride concentration in the 128 wells examined showed chloride increasing in 64 wells, and decreasing in six (significant at an alpha value of 0.05). Twenty-one wells produced water with greater than 150 mg/l chloride, eight of which also exceeded the USEPA Safe Drinking Water Guideline of 250 mg/l. Performance history (chloride vs. pumping rate) and construction (particularly well depth) also were examined in detail for each well.

Each well was assigned to a management category based its performance history, construction, and the range of background chloride appropriate for the zone within which it is located. *Acceptable wells* exhibit chloride consistently within the appropriate background range, show no positive trend, and have no record of chloride having ever exceeded 150 mg/l. *Acceptable but suspect* wells generally exhibit chloride within the appropriate range, but show a positive long-term trend or have occasionally exceeded the appropriate range. *Unacceptable but remediable* wells exhibit chloride exceeding the appropriate range, but are judged likely to be brought within it by lowering the pumping rate. *Unacceptable and irreparable* wells exhibit chloride greater than 150 mg/l and probably cannot be brought below 150 mg/l by lowering the pumping rate (typically because the well was set too deep from the beginning). Four courses of action are recommended: (1) *Continued regular monitoring* at all 126 current wells; (2) *Management plans and preventive steps* at 43 suspect wells; (3) *Reduction of pumping rate* at 34 remediable wells; and (4) *Closure and replacement* of 12 irreparable wells.

TABLE OF CONTENTS

ABSTRACT	i
LIST OF FIGURES	iii
LIST OF TABLES	iv
1.0 INTRODUCTION	1
1.1 Objectives.....	1
1.2 General geology and hydrogeology of the NGLA.....	1
1.3 Groundwater exploitation and research on Guam.....	4
2.0 SALTWATER UPCONING AND INTRUSION	5
2.1 Saltwater intrusion.....	5
2.1.1 Saltwater upconing.....	5
2.1.2 Regional saltwater intrusion.....	6
2.2 Chloride concentration benchmarks.....	6
3.0 DATA TYPES AND LIMITATIONS	7
3.1 Wellhead chloride concentrations.....	7
3.2 Drilling logs and well depths.....	10
3.3 Production data.....	10
3.4 Chloride profiles.....	10
3.5 Hydraulic conductivity.....	10
4.0 METHODS	10
4.1 Data transformation and outlier analysis.....	10
4.2 Well performance.....	11
4.2.1 Linear regression of chloride records.....	11
4.2.2 Chloride histories of production wells.....	11
4.3 Assessing causes of chloride concentrations.....	11
4.4 Assessing regional saltwater intrusion.....	11
5.0 RESULTS AND DISCUSSION	12
5.1 Well performance.....	12
5.1.1 Chloride histories.....	12
5.1.2 Chloride histories of problem wells.....	21
5.2 Chloride trends and probable causes.....	23
5.3 Agana Subbasin.....	24
5.3.1 History of chloride concentrations at production wells.....	24
5.3.2 Probable causes of chloride concentrations over 150 mg/l.....	24
5.3.3 Saltwater intrusion.....	26
5.4 Yigo Subbasin.....	31
5.4.1 History of chloride concentrations at production wells.....	31
5.4.2 Probable causes of chloride concentrations over 150 mg/l.....	31
5.4.3 Saltwater intrusion.....	33
5.5 Finegayan Subbasin.....	36
5.5.1 History of chloride concentrations at production wells.....	36
5.5.2 Probable causes of chloride concentrations over 150 mg/l.....	36
5.5.3 Saltwater intrusion.....	38
5.6 Mangilao Subbasin.....	40
5.6.1 History of chloride concentrations at production wells.....	40
5.6.2 Probable causes of chloride concentrations over 150 mg/l.....	42
5.6.3 Saltwater intrusion.....	43

6.0	CONCLUSIONS AND RECOMMENDATIONS	44
6.0.1	Wells of Acceptable Quality	45
6.0.2	Suspect Wells	45
6.0.3	Remediable Wells	46
6.0.4	Irremediable Wells	46
6.1	Agana Subbasin.....	46
6.2	Yigo Subbasin	46
6.3	Finegayan Subbasin	49
6.4	Mangilao Subbasin.....	50
6.5	Agafa Gumas and Andersen Subbasins	51
6.6	New production wells	51
	REFERENCES.....	54
	APPENDIX: Average chloride ion concentrations, rate of chloride change over time, well termination depths, and borehole anomalies for production wells (from McDonald, 2001, Appendix I)	57

LIST OF FIGURES

Figure 1.	Location map of Guam.....	2
Figure 2.	Cross-section of basal and parabasal groundwater zones.....	3
Figure 3.	Basement volcanic revisions (Vann, 2000) with updated subbasin boundaries (McDonald, 2001).....	3
Figure 4.	Cross-section of saltwater upconing and breakthrough at production wells.....	5
Figure 5.	Cross-section of regional saltwater intrusion.....	6
Figure 6.	Production wells and road locations.....	8
Figure 7.	Production well cross section	9
Figure 8.	Average chloride concentrations of production wells in northern Guam from January 1973 to December 1979.....	15
Figure 9.	Average chloride concentrations of production wells in northern Guam from January 1980 to December 1989.....	16
Figure 10.	Average chloride concentrations of production wells in northern Guam from January 1990 to December 1999.....	17
Figure 11.	Diagram of high chloride wells showing changing average chloride concentrations in the 1970s, 1980s, and 1990s.....	22
Figure 12.	Agana Subbasin production wells, observation wells, volcanic basement contours, and average chloride concentrations from 1990 to 1999	25
Figure 13.	Average chloride concentrations, average monthly production rates, and well termination depths of Agana Subbasin wells with chloride concentrations over the saltwater upconing benchmark.....	28
Figure 14.	Interpolated chloride benchmark depths at observation well EX-4.....	29
Figure 15.	Overlapping cones of depression of two production wells.....	29
Figure 16.	Interpolated chloride benchmark depths at observation well EX-1.....	30
Figure 17.	Interpolated depth of the 50% isochlor (9500 mg/l) at observation well EX-9.....	30
Figure 18.	Yigo Subbasin production wells, observation wells, volcanic basement contours, and average chloride concentrations from 1990 to 1999.....	32
Figure 19.	Average chloride concentrations, average monthly production rates, and well termination depths of Yigo Subbasin wells with chloride concentrations over the saltwater upconing benchmark.....	34

Figure 20. Interpolated chloride benchmark depths at observation well EX-7.....	35
Figure 21. Interpolated chloride benchmark depths at observation well EX-6.....	35
Figure 22. Interpolated chloride benchmark depths at observation well EX-Ghura Dededo.	36
Figure 23. Finegayan Subbasin production wells, observation wells, volcanic basement contours, and average chloride concentrations from 1990-1999.	37
Figure 24. Average chloride concentrations, average monthly production rates, and well termination depths of Finegayan Subbasin wells with chloride concentrations over the saltwater upconing benchmark.....	39
Figure 25. Interpolated chloride concentration benchmark depths at observation well EX-10.....	40
Figure 26. Mangilao Subbasin production wells, volcanic basement contours, and average chloride concentrations from 1990-1999.....	41
Figure 27. Average chloride concentrations, average monthly production rates, and well termination depths of Mangilao Subbasin wells with chloride concentrations over the saltwater upconing benchmark.....	42

LIST OF TABLES

Table 1. Production wells included in the study, by owner.	8
Table 2. Wells with significant linear regression equations ($\alpha = 0.05$) of chloride concentration (mg/l) vs. time (quarters), degrees of freedom, calculated correlation coefficients (r_{calc}), and critical correlation coefficients (r_{crit}) (McDonald, 2001, Appendix G).....	12
Table 3. Wells within each chloride benchmark category (CDM, 1982b) and the Safe Drinking Water guideline (USEPA, 2001) based on average chloride concentrations from January 1973 to December 1979.	18
Table 4. Wells within each chloride benchmark category (CDM, 1982b) and the Safe Drinking Water guideline (USEPA, 2001) based on average chloride concentrations from January 1980 to December 1989.	19
Table 5. Wells within each chloride benchmark category (CDM, 1982b) and the Safe Drinking Water guideline (USEPA, 2001) based on average chloride concentrations from January 1990 to December 1999.	20
Table 6. Wells exceeding the saltwater upconing benchmark (150 mg/l) and Safe Drinking Water guideline (250 mg/l) for chloride concentrations during the 1970s, 1980s, and 1990s.	21
Table 7. Agana Subbasin production wells in chloride benchmark categories based on average chloride concentrations in the 1990s.....	26
Table 8. Yigo Subbasin production wells in chloride benchmark categories based on average chloride concentrations in the 1990s.....	33
Table 9. Finegayan Subbasin production wells in chloride benchmark categories based on average chloride concentrations in the 1990s.....	38
Table 10. Mangilao Subbasin production wells in chloride benchmark categories based on average chloride concentrations in the 1990s.....	41
Table 11. Recommendations for Agana Subbasin wells.....	46
Table 12. Recommendations for Yigo Subbasin wells.	49
Table 13. Recommendations for Finegayan Subbasin wells.	50
Table 14. Recommendations for Mangilao Subbasin wells.....	51
Table 15. Recommendations for Agafa Gumas and Andersen Subbasin wells.	52

Chloride History and Trends of Water Production Wells in the Northern Guam Lens Aquifer

1.0 INTRODUCTION

The Northern Guam Lens Aquifer (NGLA) is Guam's primary source of freshwater. It currently provides approximately 80% of the island's municipal water supply. Aggressive groundwater production began in the 1940s, and has since quadrupled to almost 152,000 m³/day or about 40 million gallons per day (mgd). With water demand rising and threats to water quality proliferating, proper management of the freshwater lens has become critical to the welfare of the island's population. Groundwater studies over the last 25 years (CDM, 1982b; Clayshulte, 1985; Mink, 1976) have raised concerns regarding salt-water contamination. In fact, chloride ion (from this point on referred to as "chloride") concentrations at a number of water wells have indicated saltwater contamination for nearly three decades.

1.1 Objectives

This project's three objectives were to: (1) assess the incidence of chloride contamination in production wells in the NGLA, (2) identify probable causes for high or increasing chloride concentrations, and (3) provide guidelines for remedying and managing the risk of chloride contamination in the NGLA.

1.2 General geology and hydrogeology of the NGLA

Guam is the largest island in the Mariana Archipelago (Figure 1). It is a raised volcanic island, the northern half of which is dominated by a limestone plateau. Northern and southern Guam are separated by a fault, which runs northwest to southeast in central Guam (Figure 1). Water resources in the south are predominantly streams and a surface water reservoir, while groundwater from the limestone aquifer is the sole source of potable water in the north.

In northern Guam, infiltrating rainwater dissolves the limestone, creating karst features (such as sinkholes, caves, and dissolution-widened fissures) that increase hydraulic conductivity (a parameter used to calculate groundwater flow rates). The resulting karst aquifer has no permanent streams. The sole freshwater resource is a freshwater lens (see Figure 2) contained within limestone, which rests on a volcanic basement (CDM, 1982b; Mink, 1976). The lens is bound by basement topography that separates the aquifer into subbasins (in which groundwater is shunted from higher to lower volcanic elevations, much as surface water travels across the ground surface in a watershed). Basement volcanic contours and consequent subbasin boundaries were originally mapped by CDM (1982b), with volcanic contours later updated by Vann (2000). Although Vann's contours were interpolated from drilling records and are therefore subject to error, they are based on the best data available and represent the most recent version of Northern Guam volcanic elevations. McDonald (2001) used Vann's (2000) revisions to update subbasin boundaries (Figure 3), which were used in this project.

As defined by Mink (1976), the lens can be divided into basal and parabasals zones (Figure 2). *Basal* water floats on top of the denser saltwater, with graduated mixing at the interface. *Parabasals* water is directly underlain by basement volcanic rock. The salt/freshwater interface meets the volcanic basement at the *saltwater toe* (CDM, 1982b). Lens geometry in parabasals areas is dependent on freshwater recharge rates, basement elevations, basement slopes, and aquifer conductivity.

Aquifer characteristics, such as solution features and clay content, differ among the limestone units. The Agana Argillaceous member of the Mariana limestone in the southern part of the NGLA can contain as much as 10% clay-sized particles by volume (Mink, 1976). Local hydraulic conductivity, which describes groundwater and aquifer characteristics in relatively small areas, in argillaceous limestone can be an order of magnitude below that of clean limestone, which has typical local hydraulic conductivity values around 200 feet per day (ft/d) (CDM, 1982b). Regional hydraulic conductivities are lowest in the southern (argillaceous) portion of the aquifer, ranging from 500 to 1,500 ft/d (CDM, 1982b). Regional hydraulic conductivity in the clean limestone to the north, however, can reach as high as

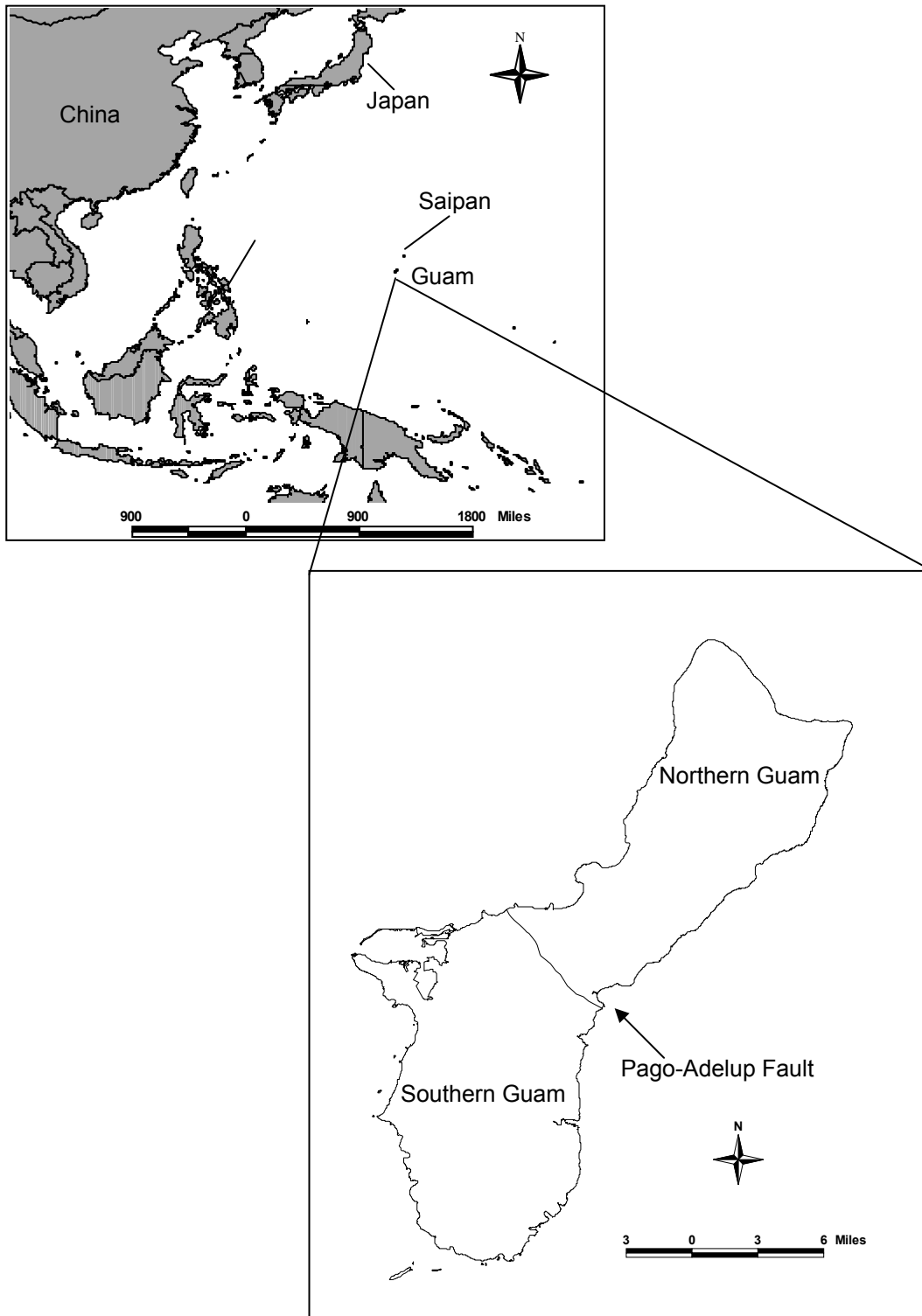

Figure 1. Location map of Guam. The Pago-Adelup Fault separates northern and southern Guam.

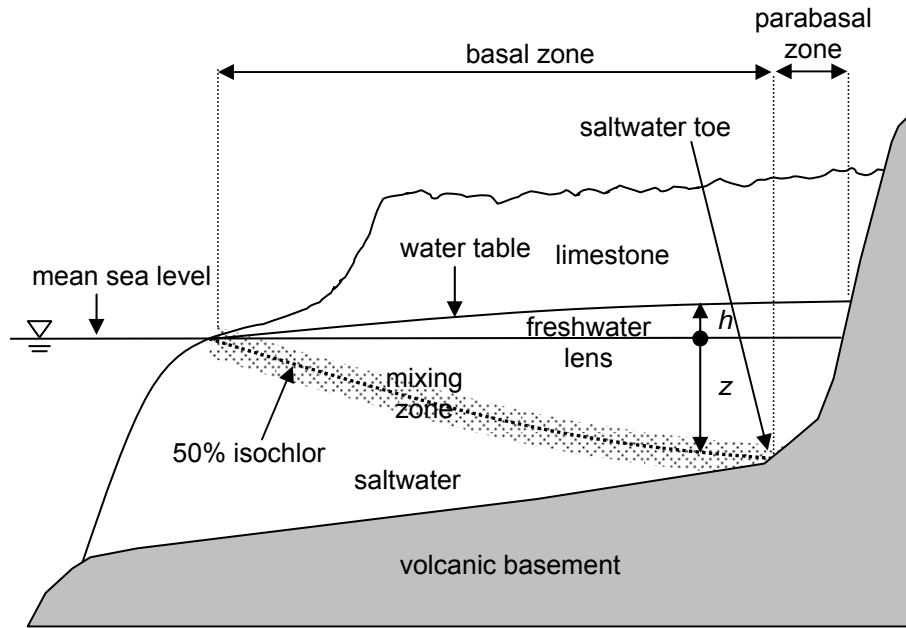

Figure 2. Cross-section of basal and parabasal groundwater zones. In basal zones, the thickness (h) of the freshwater lens from mean sea level to the water table is at maximum, $1/40^{\text{th}}$ of the distance (z) from mean sea level to the 50% isochlor (where the chloride ion concentration is half that of seawater). Image is not drawn to scale.

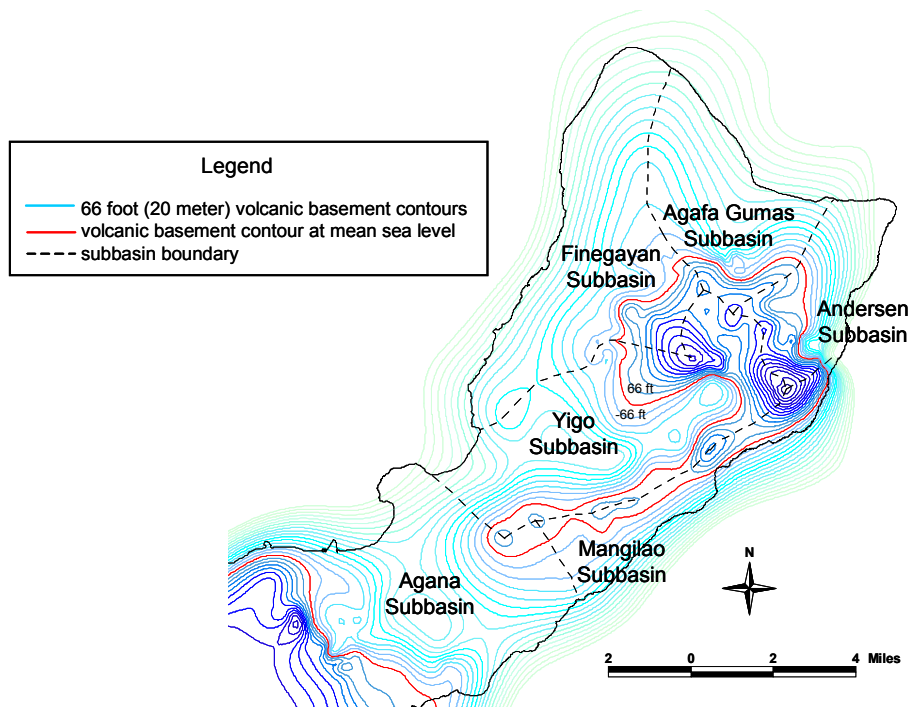

Figure 3. Basement volcanic revisions (Vann, 2000) with updated subbasin boundaries (McDonald, 2001).

15,000 to 20,000 ft/d (CDM, 1982b). Modeling studies (Contractor, 1983; Contractor and Srivastava, 1990; Jocson et al., 2002) have shown that best fit simulations require a regional hydraulic conductivity of about 20,000 ft/d.

1.3 Groundwater exploitation and research on Guam

Stearns (1937) published Guam's first major water resource report. Four years later, the U. S. Naval administration brought 60 to 70 wells on-line, with a total groundwater production capacity of 6 to 8 million gallons per day (mgd) (Ward et al., 1965). However, many of the wells produced water high in chlorides as a result of improper siting, design, or both (Ward et al., 1965). Intensive well drilling continued in the 1960s to meet an increasing water demand.

Mink (1976) reported the effects of groundwater extraction in various areas of the NGLA and included recommendations for aquifer development. Guam's most comprehensive groundwater study is the *Northern Guam Lens Study* (NGLS), which was conducted by Camp, Dresser and McKee, Inc. (CDM) under the direction of John Mink (CDM, 1982a; 1982b; 1982c). The NGLS (1982c) included guidelines that prescribed appropriate well depths and pumping rates in gallons per minute (gpm) for parabasal and basal areas of the NLS:

groundwater area	maximum pumping rate (gpm)	preferred depth (ft below msl)	maximum depth (ft below msl)
parabasal areas in the southern part of the Agana Subbasin	200 350 (under special conditions)	--	50
parabasal areas in the upper part of the Yigo Subbasin	750	--	50 to 60
other parabasal areas	500	--	50
basal area with freshwater hydraulic head < 4 ft	200	≤ 25	40
basal area with freshwater hydraulic head > 4 ft	350	≤ 35	50

The University of Guam's Water and Energy Research Institute of the Western Pacific (WERI) also contributed to the project. The Guam Environmental Protection Agency (GEPA) currently bases local regulations on NGLS aquifer subbasin delineations (CDM, 1982b), management zone delineations (areas within subbasins), and computer model estimates of a sustainable yield of about 57 mgd. The NGLS reported that production in certain management zones exceeded sustainable yield estimates. The NGLS also included a groundwater quality assessment and a detailed well construction manual (CDM, 1982a) which established guidelines for well siting, production rates, and engineering specifications for constructing production wells.

Clayshulte (1985) reported the most detailed statistical water quality analyses, to date, of public water wells. Data from September 1976 through December 1983 on pH, conductivity, total dissolved solids, alkalinity, hardness, chlorides, turbidity, and bacteria were subjected to regression and cluster analyses, as well as analyses of variance. Although he recommended that a number of wells be shut down because of their high chloride concentrations, Clayshulte did not attempt a definitive analysis of the relationship between well production rates and chloride ion concentrations. *Historical Water Quality of PUAG Production Water Wells* (Clayshulte, 1985) was intended to be a baseline study for basic water quality parameters. However, Clayshulte's (1985) data set started in October 1976, overlooking more

than three years of data from the available chloride record (which starts in January 1973), and which have been included in the present study.

The Barrett Consulting Group (BCG, 1992) produced a follow-up report to the NGLS that introduced a transient computer model to revise aquifer management divisions and increase estimated sustainable yield to 80 mgd. As with other studies, wells with high chloride concentrations were reported. Consistently high chloride levels were observed at seven wells (A-9, A-10, A-13, A-14, A-17, A-18, and A-19), while four wells (F-4, F-6, F-10, and NCS-A) were found to occasionally exhibit high chloride concentrations. The chloride histories of these eleven wells, along with others, are discussed in detail in Section 5.

High chloride levels at production wells have been reported since 1965. Since then, a large amount of chloride data have been collected, but until the study reported herein, no systematic and exhaustive analysis has made to rigorously evaluate the incidence and probable causes of chloride contamination in the NGLA. This project was undertaken to conduct such an analysis.

2.0 SALTWATER UPCONING AND INTRUSION

2.1 Saltwater intrusion

2.1.1 Saltwater upconing

Saltwater intrusion can be manifested in two ways, by local upconing and by regional intrusion. Saltwater upconing, which occurs only in basal areas, is the movement of a cone of brackish water or saltwater from the interface toward a well screen (Figure 4). Although all basal production wells cause

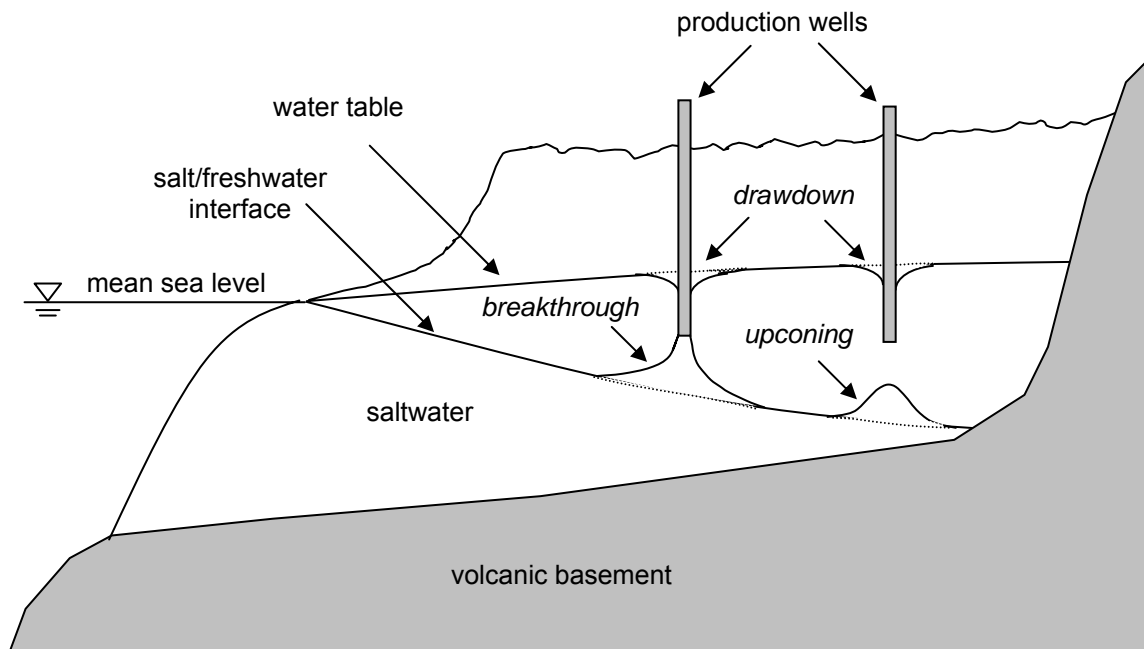

Figure 4. Cross-section of saltwater upconing and breakthrough at production wells.

some degree of upconing to occur (Todd, 1960), it becomes a serious problem only if the cone rises to some critical depth (dependent on lens thickness, well depth, and pumping rate) where it becomes

unstable (Chandler and McWhorter, 1975) and breaks through the freshwater layer to intercept the well screen (Figure 4). Saltwater upconing is a function of production rate, well depth, recharge rates, hydraulic conductivity, and lens geometry. High pumping rates, proximity of the well bottom to the salt/freshwater interface, and high vertical hydraulic conductivity favor upconing (Falkland, 1991). Lens geometry becomes a more important the closer a well is drilled to the coast, where the freshwater lens thins and is influenced by tidal fluctuations, making chloride changes more sensitive with depth. In addition, the production of salty water in a single well or well field may lower the water table as well as increase subsurface mixing and intensify the upconing problem in that region. Thus, pumping rates and well depth should be based on local conditions. Generally, to minimize saltwater upconing, a number of shallow, moderately pumping wells is preferable to a single deep, high production well.

2.1.2 Regional saltwater intrusion

While upconing is a local effect within only the basal zone of the aquifer, regional saltwater intrusion involves the inland and upward movement of the interface (see Figure 5) across an entire

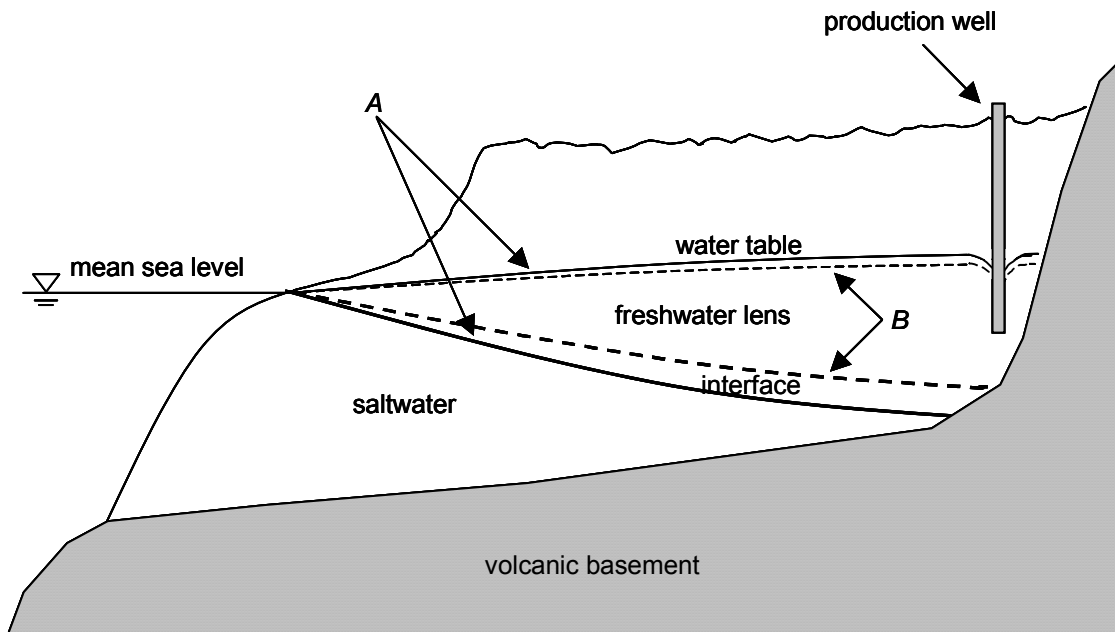

Figure 5. Cross-section of regional saltwater intrusion. The interface moves upward and inland while the water table moves drops, from position A to position B.

subbasin, in response to a basin-wide lowering of water table elevation. As the freshwater lens thickness decreases, the chloride concentration at any given level tends to increase across the entire subbasin, including the saltwater toe along the margin of the parabasal zone (Falkland, 1991). As the saltwater toe moves inland, the parabasal zone contracts. Regional intrusion thus affects the entire subbasin, including the parabasal as well as the basal zone.

2.2 Chloride concentration benchmarks

The USEPA Secondary Safe Drinking Water (SDW) guideline for chloride concentration, above which drinking water is considered aesthetically unpleasing, is 250 milligrams per liter (mg/l) (USEPA, 2001). Seawater typically contains 19,000 mg/l or greater chloride, while rainwater chloride is about 1 mg/l or less. Groundwater concentrations may range from a few mg/l near the lens surface to 100%

seawater at the interface beneath the basal zone. Within the lens, concentrations can fluctuate at any given elevation in response to long-term and short-term sea level fluctuations, tidal pumping, seasonal changes in recharge rates, and chloride from sea spray mixed with storm water during heavy storms. CDM's (1982b) typical chloride ranges for the different environments within the NGLA (and which were recommended as criteria for engineering and management decisions) are:

- Parabasal groundwater: < 30 mg/l
- Saltwater toe groundwater: 30 to 70 mg/l
- Basal groundwater: > 70 to < 150 mg/l
- Saltwater upconing indicator level: 150 mg/l.

Chloride concentrations vary substantially within each of these environments and may overlap or grade into the ranges recognized for other environments. However, these ranges (which reflect basic natural physical conditions and the regulatory guideline) are relevant to engineering design and system management. They therefore provide logical and useful benchmarks against which to measure trends in chloride concentration, evaluate suspect contamination causes, and recommend appropriate corrective actions.

3.0 DATA TYPES AND LIMITATIONS

3.1 Wellhead chloride concentrations

This study makes use of wellhead chloride sampling records obtained from well owners and from GEPA water quality reports for 128 production wells (Figure 6 and Table 1 of this report, and Appendix A of McDonald (2001)) from 1973 to 1999. Other wells were in operation from 1973 to 1999, but were not systematically sampled for chloride. Samples from water extracted at the wellhead are a composite of water drawn from across the entire length of the well screen, and thus may reflect an average of concentrations that vary at different depths across the screen. Trends in chloride concentrations in such samples are nevertheless a practical, reliable, and therefore commonly used indicator of chloride contamination (FAO, 1997).

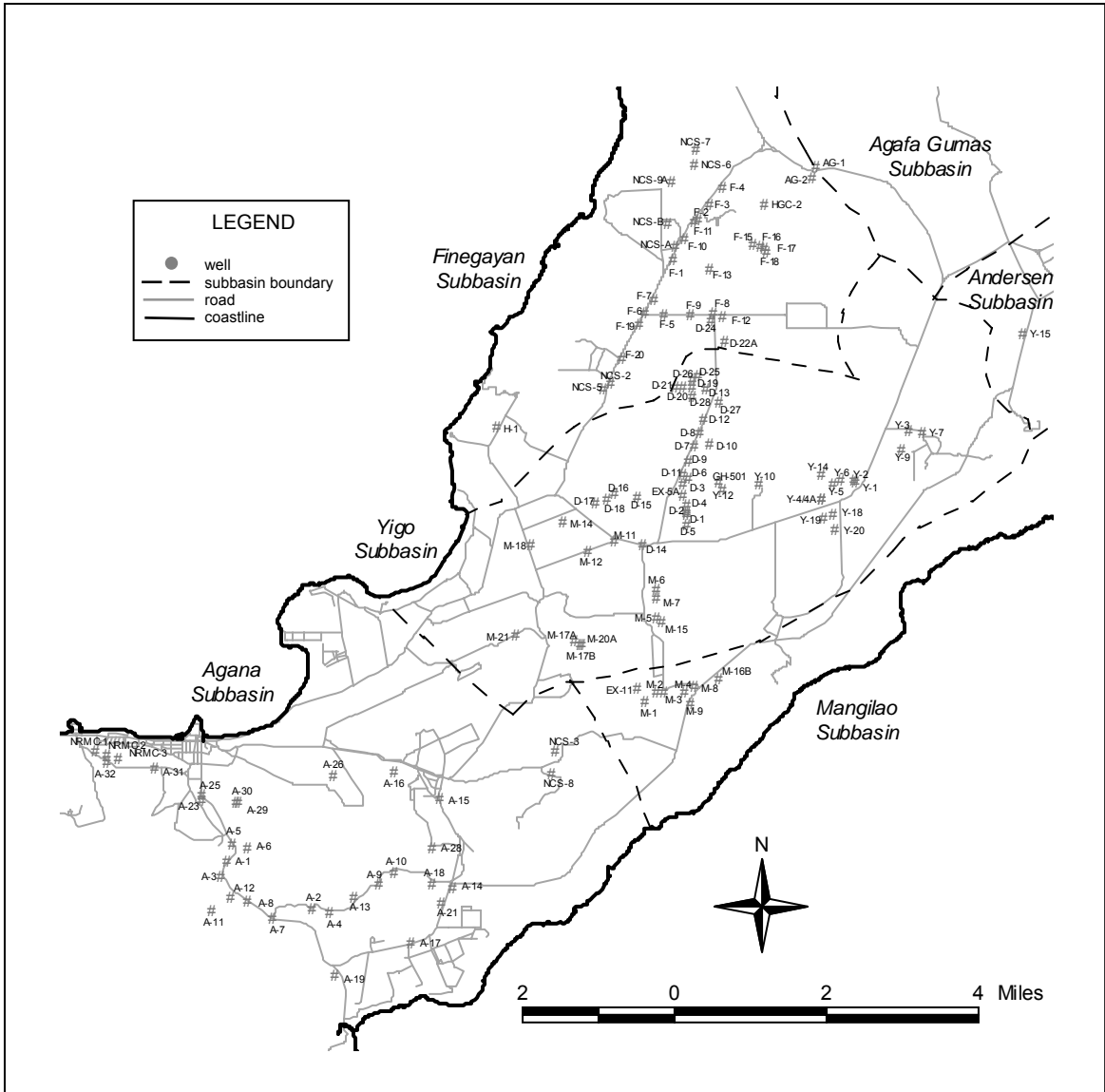

Figure 6. Production wells and road locations.

Table 1. Production wells included in the study, by owner.

Well	Owner	Well	Owner	Well	Owner	Well	Owner
A-1	GWA	D-3	GWA	F-6	GWA	M-17B	GWA
A-2	GWA	D-4	GWA	F-7	GWA	M-18	GWA
A-3	GWA	D-5	GWA	F-8	GWA	M-20A	GWA
A-4	GWA	D-6	GWA	F-9	GWA	M-21	GWA
A-5	GWA	D-7	GWA	F-10	GWA	NCS-A	U. S. Navy
A-6	GWA	D-8	GWA	F-11	GWA	NCS-B	U. S. Navy
A-7	GWA	D-9	GWA	F-12	GWA	NCS-2	U. S. Navy
A-8	GWA	D-10	GWA	F-13	GWA	NCS-3	U. S. Navy
A-9	GWA	D-11	GWA	F-15	GWA	NCS-5	U. S. Navy
A-10	GWA	D-12	GWA	F-16	GWA	NCS-6	U. S. Navy
A-11	GWA	D-13	GWA	F-17	GWA	NCS-7	U. S. Navy
A-12	GWA	D-14	GWA	F-18	GWA	NCS-8	U. S. Navy
A-13	GWA	D-15	GWA	F-19	EarthTech	NCS-9A	U. S. Navy
A-14	GWA	D-16	GWA	F-20	EarthTech	NRMC-1	U. S. Navy
A-15	GWA	D-17	GWA	GH-501	GWA	NRMC-2	U. S. Navy
A-16	GWA	D-18	GWA	H-1	GWA	NRMC-3	U. S. Navy
A-17	GWA	D-19	GWA	HGC-2	GWA	Y-1	GWA
A-18	GWA	D-20	GWA	M-1	GWA	Y-2	GWA
A-19	GWA	D-21	GWA	M-2	GWA	Y-3	GWA
A-21	GWA	D-22A	GWA	M-3	GWA	Y-4	GWA
A-23	GWA	D-24	GWA	M-4	GWA	Y-4A	GWA
A-25	GWA	D-25	EarthTech	M-5	GWA	Y-5	GWA
A-26	GWA	D-26	EarthTech	M-6	GWA	Y-6	GWA
A-28	GWA	D-27	EarthTech	M-7	GWA	Y-7	GWA
A-29	GWA	D-28	EarthTech	M-8	GWA	Y-9	GWA
A-30	GWA	EX-5A	GWA	M-9	GWA	Y-10	GWA
A-31	GWA	EX-11	GWA	M-11	GWA	Y-12	GWA
A-32	GWA	F-1	GWA	M-12	GWA	Y-14	GWA
AG-1	GWA	F-2	GWA	M-14	GWA	Y-15	GWA
AG-2	GWA	F-3	GWA	M-15	GWA	Y-18	EarthTech
D-1	GWA	F-4	GWA	M-16B	GWA	Y-19	EarthTech
D-2	GWA	F-5	GWA	M-17A	GWA	Y-20	EarthTech

The Guam Waterworks Authority (GWA) began collecting wellhead chloride data in January 1973. Their laboratory used Standard Method 4500-CL (Clesceri et al., 1989) to analyze samples. GWA collected chloride data monthly until 1984, when they decreased sampling frequency to quarterly. Some records are incomplete, and though samples were generally taken each quarter, the sampling date varied within quarters, so that some quarterly samples are more or less than three months apart. The sampling frequency for EarthTech and Navy wells ranged from monthly to quarterly, with records beginning in 1985.

3.2 Drilling logs and well depths

United States Geological Survey (USGS) well drilling records provided the majority of the historical borehole and well depth information. Data are on file at WERI at the University of Guam and a sample is shown in McDonald (2001), Appendix B. Data not found in USGS records were obtained from the *Northern Guam Lens Study* (CDM, 1982b) and *Historical Water Quality of PUAG Production Wells* (Clayshulte, 1985). Recent well drilling records were obtained from GEPA files, but rehabilitation records were unavailable from GWA. A schematic cross section of a typical production well is shown in Figure 7.

3.3 Production data

Monthly production volumes from January 1980 through July 1998 (McDonald, 2001, Appendix C) were obtained from the USGS, which catalogued the information from GWA and GEPA. The data were used to calculate average monthly pumping rates in gpm. Average monthly pumping rates were computed with the assumption that well operations were consistent through each day in each month.

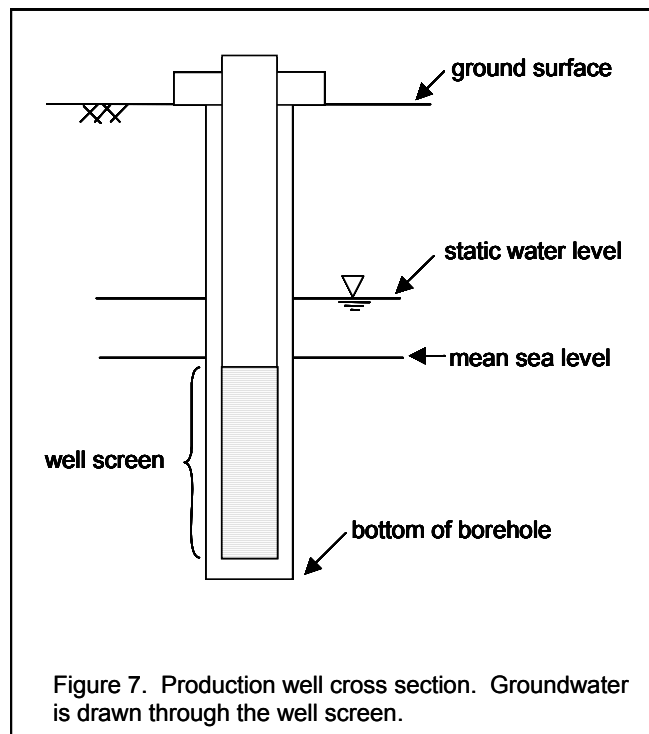

3.4 Chloride profiles

The USGS recorded chloride profiles of seven observation wells, from September 1982 through February 1996 (McDonald, 2001, Appendix D). However, the profiling frequency varied from quarterly to annual sampling. Some anomalies were noted, most of which were unlikely high chloride concentrations reported at shallow depths. (There are no known natural processes that might account for such anomalies. Rainwater seepage into the borehole would lower rather than increase chlorides at shallow depths.) Based on discussion with the USGS (J. Torikai, personal communication, 12/22/2000), such anomalous data were corrected or removed.

3.5 Hydraulic conductivity

Local hydraulic conductivity data were available for only 26 wells (McDonald, 2001, Appendix E) of the 128 study wells. These data were obtained from driller and GEPA files, as well as groundwater reports (CDM, 1982b; 1982c; Mink, 1976). For this study, local hydraulic conductivity data were insufficient to support a comprehensive evaluation of the general relationship between local hydraulic conductivity and well chloride concentrations.

4.0 METHODS

4.1 Data transformation and outlier analysis

Chloride data collected more frequently than four times a year were averaged over three-month intervals to create a data set of uniform quarterly frequency (McDonald, 2001, Appendix F). The influence of human error (during sample analysis or data retrieval) was reduced by determining if outliers (unusually high or low values with no obvious cause, e.g., a high chloride level reported during a period of decreased production) should be removed from the data set. Anomalous values were subjected to a

discordancy test for a single outlier in a normal sample where the population mean and standard deviation are not known (Barnett and Lewis, 1984). Questionable minimum values were tested using the same procedure. Observations failing the outlier test were removed from data sets. Final chloride data sets are contained in McDonald (2001, Appendix A).

4.2 Well performance

4.2.1 Linear regression of chloride records

Linear regressions were applied to quarterly data from each well to determine if the concentrations exhibited significant temporal trends. Equations were checked for significance at an alpha (α) level of 0.05 by comparing calculated correlation coefficients (r_{calc}) to critical correlation coefficients (r_{crit}) (Zarr, 1984, Table B.16: critical values of the correlation coefficient, r). Regression results (i.e., slopes and intercepts) were deemed significant if calculated r_{calc} values equaled or exceeded r_{crit} .

4.2.2 Chloride histories of production wells

In addition to the regression statistics, the minimum, maximum, mode, median, mean, and standard deviation of historical chloride concentrations were calculated for each well. These statistics were also calculated separately for the decadal intervals from January 1973 to December 1979, January 1980 to December 1989, and January 1990 to December 1999. These intervals were chosen to provide a readily understandable characterization of long-term changes between intervals sufficiently long to smooth out the variations between annual and seasonal fluctuations. Maps showing average chloride concentrations, as well as the location of wells with increasing and decreasing trends, were prepared for intervals from 1973 to 1979, 1980 to 1989, and 1990 to 1999 (see Section 5). Wells were identified where chloride concentrations were rising or had risen over the benchmarks of 30, 70, 150, and 250 mg/l.

4.3 Assessing causes of chloride concentrations

Factors examined in assessing probable causes for high chloride included screen and termination depths and pumping rates, where such data were available (see Appendix, taken from McDonald (2001), Appendix I). Well boring logs, where available, were examined for additional clues, such as the presence and location of voids or other geological features that might affect well performance. Attention was also given to locational factors, particularly the proximity to the mapped sea-level contour of the volcanic basement (as an indicator of proximity to the parabasal zone).

To assess the effect of well screen and borehole termination depths on chloride concentrations we estimated the background concentrations at the corresponding depths by linear interpolation of chloride profiles measured in the nearest of the USGS observation wells in the subbasin, where such data were available. Interpolated depths corresponding to the benchmarks (30 mg/l, 70 mg/l, 150 mg/l, and 250 mg/l) were also noted (McDonald, 2001, Appendix D). In areas lacking observation wells, we compared a well's characteristics and chloride histories with those of neighboring production wells.

Production data were not available for the 1970s. For January 1980 to July 1998, however, we were able to compare average monthly production rates (McDonald, 2001, Appendix C) against the chloride histories.

4.4 Assessing regional saltwater intrusion

To assess whether regional saltwater intrusion might be significant, we examined temporal trends of the 50% isochlor depth in subbasins instrumented with observation wells. The depth of the 50% isochlor (9,500 mg/l) was linearly interpolated (McDonald, 2001, Appendix D) and then linearly regressed in the same manner as production well chloride concentrations (described above).

5.0 RESULTS AND DISCUSSION

5.1 Well performance

5.1.1 Chloride histories

Linear regression of chloride concentrations over time revealed significant increasing trends for 64 of 128 wells (Table 2). Six wells (M-9, M-20A, NCS-2, NCS-5, NCS-6, and NCS-8) exhibited significant decreasing trends (Table 2). For M-9 and NCS-5, however, each well's full record average was over 150 mg/l (McDonald, 2001). Of the wells with increasing trends, thirteen (A-10, A-13, A-14, A-17, A-18, A-19, A-21, A-28, D-8, F-4, F-6, F-10, and M-1) exhibited full record average concentrations exceeding the CDM (1982b) saltwater-upconing benchmark of 150 mg/l (McDonald, 2001).

Table 2. Wells with Significant Linear Regression Equations ($\alpha = 0.05$) of Chloride Concentration (mg/l) vs. Time (quarters), Degrees of Freedom, Calculated Correlation Coefficients (r_{calc}), and Critical Correlation Coefficients (r_{crit}) (McDonald, 2001, Appendix G).

Well	Regression Equation	Degrees of Freedom	r_{calc}	r_{crit}
A-1	$y = 0.0425x + 17.036$	100	0.3312	0.1950
A-2	$y = 0.075x + 16.699$	103	0.5406	0.1920
A-4	$y = 0.3212x + 11.782$	102	0.8249	0.1930
A-5	$y = 0.0584x + 15.987$	103	0.4015	0.1920
A-6	$y = 0.1318x + 14.743$	103	0.5898	0.1920
A-7	$y = 0.0684x + 19.12$	101	0.3828	0.1940
A-9	$y = 0.3113x + 150.64$	100	0.398	0.1950
A-10	$y = 1.2395x + 164.58$	99	0.6456	0.1960
A-13	$y = 1.3562x + 248.52$	100	0.5335	0.1950
A-14	$y = 0.6057x + 246.31$	99	0.3738	0.1960
A-17	$y = 1.1094x + 260.19$	97	0.437	0.1980
A-18	$y = 2.3047x + 200.31$	91	0.7493	0.2040
A-19	$y = 1.2968x + 240.62$	91	0.3868	0.2040
A-21	$y = 1.8543x + 189.73$	96	0.6962	0.1990
A-23	$y = 0.5201x + 14.475$	62	0.5664	0.2460
A-25	$y = 1.0424x + 9.3614$	58	0.692	0.2540
A-31	$y = 0.1645x + 27.724$	38	0.4257	0.3120
AG-1	$y = 0.1266x + 33.837$	96	0.4265	0.1990
AG-2	$y = 0.0736x + 16.798$	72	0.236	0.2290
D-1	$y = 0.136x + 52.172$	104	0.4359	0.1910
D-2	$y = 0.0893x + 55.105$	101	0.2844	0.1940
D-6	$y = 0.096x + 47.639$	101	0.3071	0.1940
D-7	$y = 0.0933x + 48.51$	103	0.3097	0.1920
D-8	$y = 1.0543x + 120.55$	103	0.5623	0.1920
D-9	$y = 0.5303x + 106.88$	101	0.4914	0.1940
D-11	$y = 0.2778x + 69.217$	103	0.3607	0.1920
D-14	$y = 0.3782x + 28.417$	100	0.6551	0.1950
D-15	$y = 0.1598x + 80.186$	97	0.3038	0.1980
D-16	$y = 0.1553x + 78.033$	76	0.2514	0.2230

Well	Regression Equation	Degrees of Freedom	r_{calc}	r_{crit}
D-17	$y = 2.6149x + 14.595$	78	0.8264	0.2200
D-18	$y = 0.485x + 58.475$	70	0.4746	0.2320
EX-5A	$y = 0.3135x + 33.171$	49	0.3183	0.2760
EX-11	$y = 0.272x + 33.916$	53	0.4079	0.2655
F-1	$y = 0.4054x + 67.4$	101	0.4484	0.1940
F-2	$y = 0.1915x + 102.27$	96	0.3391	0.1990
F-4	$y = 1.0731x + 88.52$	90	0.4508	0.2050
F-5	$y = 0.5027x + 46.605$	90	0.678	0.2050
F-6	$y = 1.006x + 129.32$	92	0.4265	0.2030
F-7	$y = 0.4104x + 51.954$	91	0.7251	0.2040
F-8	$y = 0.1005x + 16.915$	86	0.4896	0.2100
F-10	$y = 0.5091x + 156.92$	73	0.2381	0.2275
F-11	$y = 0.3393x + 102.05$	76	0.254	0.2230
F-12	$y = 0.6031x + 13.045$	33	0.3489	0.3340
F-19	$y = 26.967x + 41.567$	3	0.9276	0.8780
GH-501	$y = 0.2051x + 77.066$	55	0.3544	0.2610
H-1	$y = 0.7146x + 74.393$	97	0.65	0.1980
M-1	$y = 0.4488x + 143.11$	104	0.4066	0.1910
M-2	$y = 0.3945x + 68.269$	102	0.4893	0.1930
M-3	$y = 0.0437x + 24.25$	103	0.2423	0.1920
M-4	$y = 0.0678x + 19.967$	103	0.3051	0.1920
M-5	$y = 0.2179x + 37.763$	103	0.5416	0.1920
M-6	$y = 0.2452x + 60.541$	97	0.2352	0.1980
M-7	$y = 0.1064x + 32.775$	103	0.3867	0.1920
M-8	$y = 0.0628x + 20.086$	103	0.4569	0.1920
M-9	$y = -0.5031x + 224.67$	102	0.2396	0.1930
M-12	$y = 0.2902x + 62.846$	92	0.3707	0.2030
M-14	$y = 0.2541x + 30.032$	96	0.3808	0.1990
M-20A	$y = -3.647x + 94.658$	10	0.8107	0.5760
NCS 2	$y = -1.7909x + 146.03$	18	0.472	0.4440
NCS 5	$y = -4.652x + 268.24$	17	0.4815	0.4560
NCS 6	$y = -0.6104x + 60.092$	18	0.4557	0.4440
NCS 8	$y = -2.9102x + 106.95$	18	0.7346	0.4440
NRMC 1	$y = 0.1318x + 22.854$	18	0.4653	0.4440
NRMC 2	$y = 5.2334x + 14.018$	17	0.5325	0.4560
Y-1	$y = 0.065x + 18.5$	101	0.547	0.1940
Y-2	$y = 0.0753x + 18.723$	101	0.6442	0.1940
Y-3	$y = 0.0693x + 16.945$	100	0.3795	0.1950
Y-4	$y = 0.1086x + 20.189$	60	0.4281	0.2500
Y-5	$y = 0.1963x + 32.743$	78	0.5062	0.2200
Y-9	$y = 0.0854x + 20.056$	42	0.3257	0.2970

In addition to studying the trends indicated by the regression statistics, we tabulated (Tables 3, 4, and 5) and mapped (Figures 8, 9, and 10) the values and trends in the decadal-averaged chloride concentrations for the 1970s, 1980s, and 1990s for each of the 128 wells. The data thus displayed provide a simple and transparent characterization of the historical magnitudes of chloride concentrations in each well, as well as the direction and rate of change over time. For each well at which regression analyses indicated significant temporal trends (marked with crosses for positive trends and triangles for negative trends on the maps), we checked the series of decadal averages and other basic statistics (McDonald, 2001, Appendix H) for consistency with the regression statistics. For wells at which the regression analyses did not reveal a significant trend (marked with dots on the maps), we examined raw data and the decadal statistics for hints of possible trends or correlation with trends manifest in nearby wells. These analyses are described by subbasin, in the subsequent sections of this chapter.

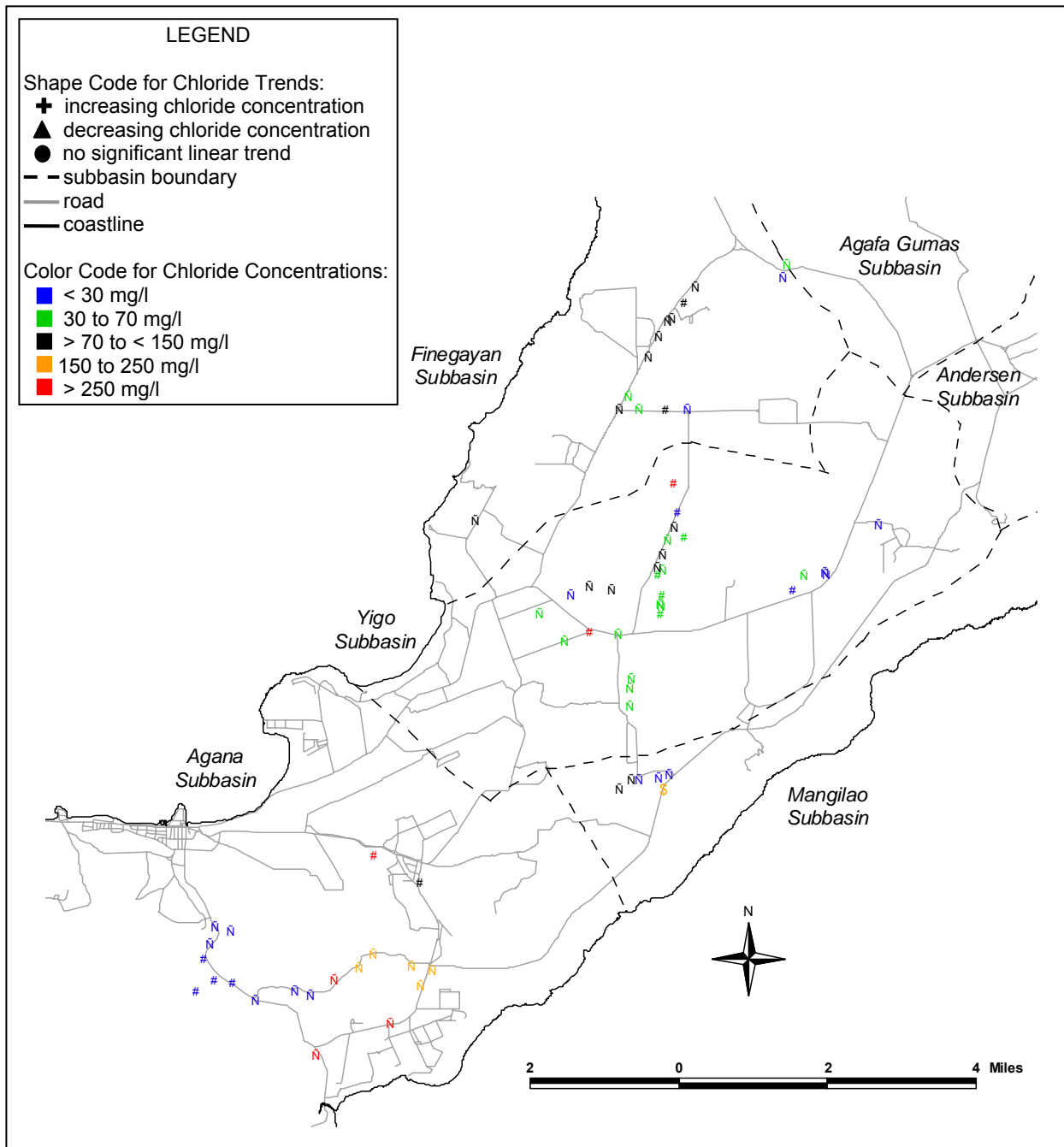
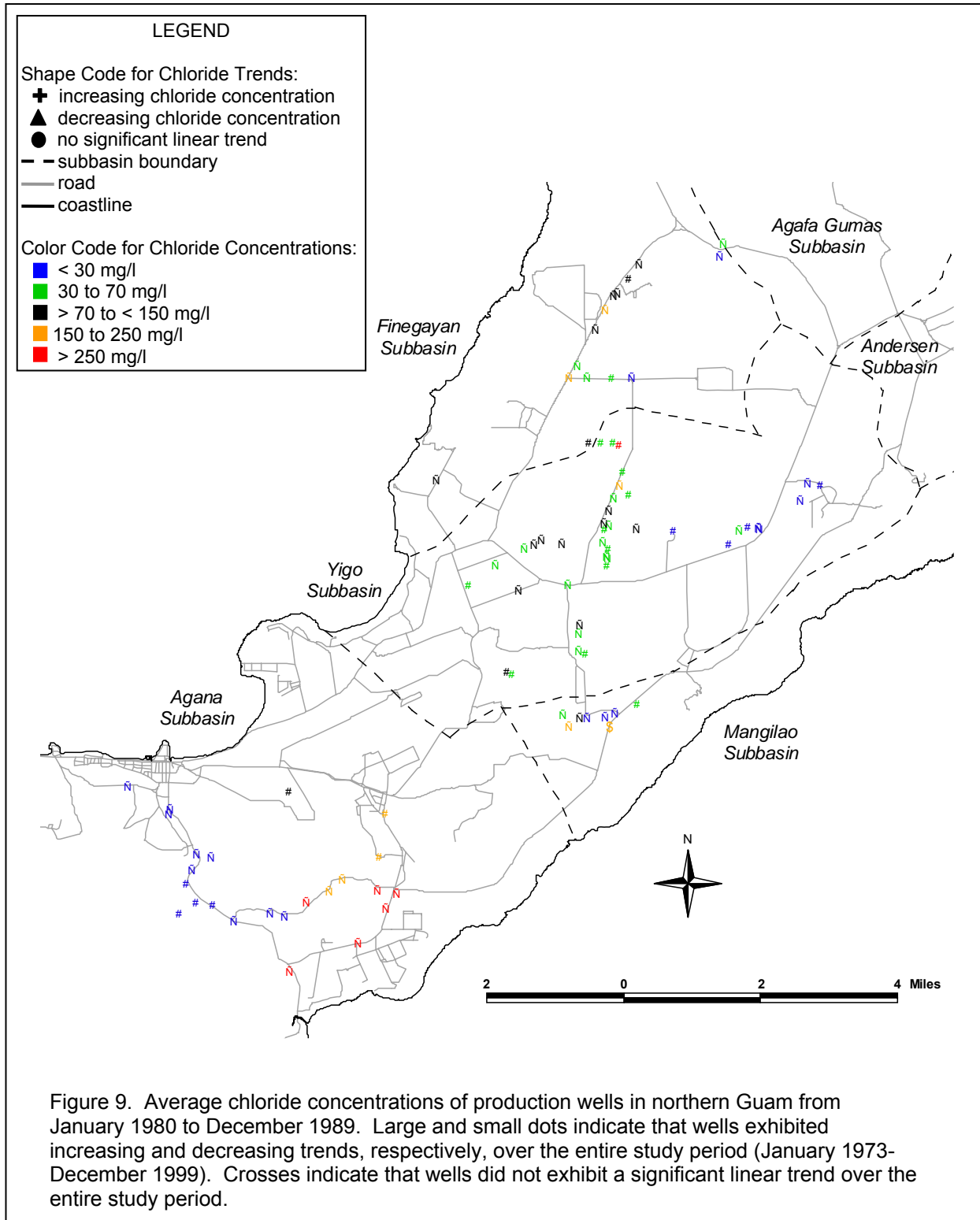

Figure 8. Average chloride concentrations of production wells in northern Guam from January 1973 to December 1979. Large and small dots indicate that wells exhibited increasing and decreasing trends, respectively, over the entire study period (January 1973-December 1999). Crosses indicate that wells did not exhibit a significant linear trend over the entire study period.



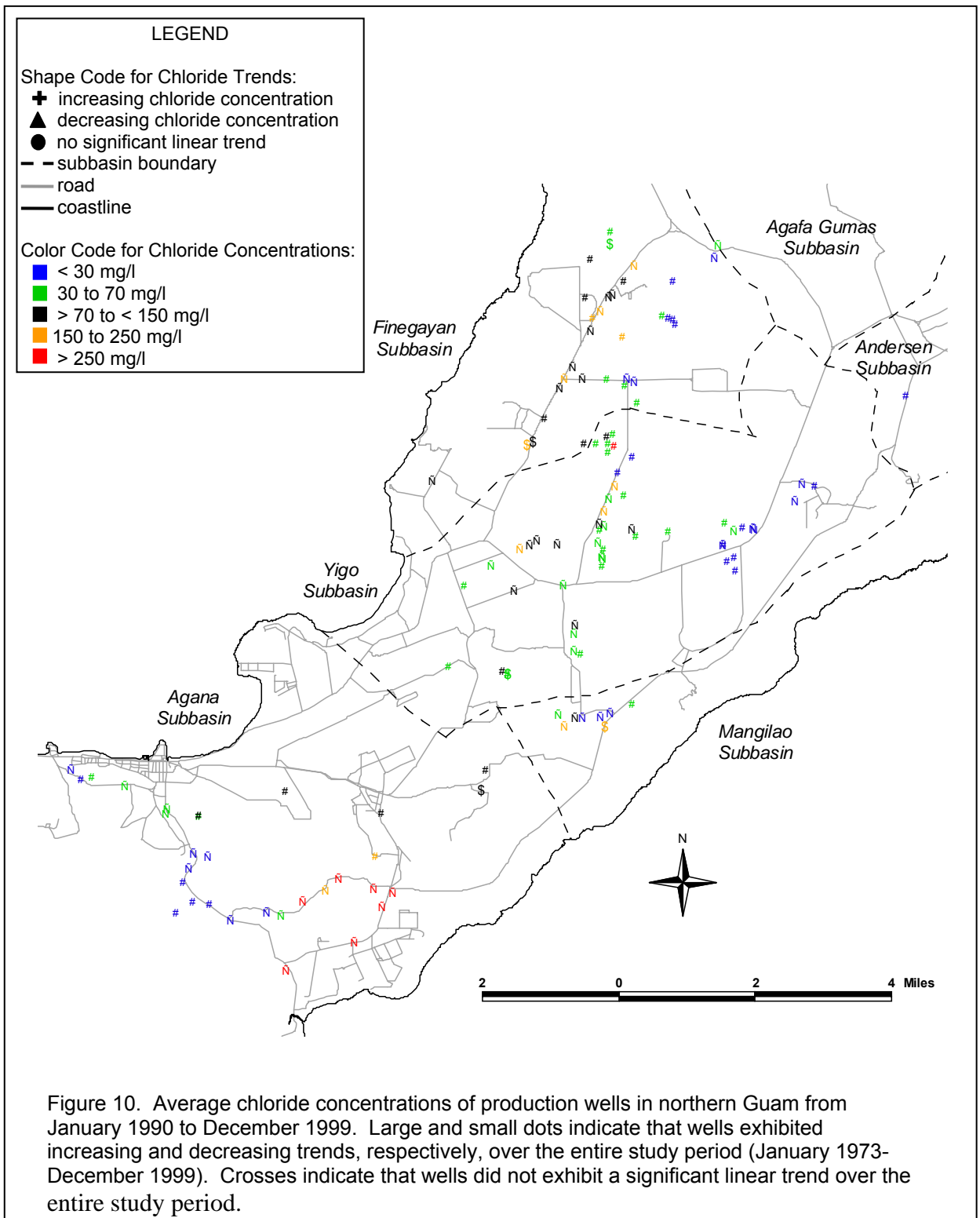

Table 3. Wells within each chloride benchmark category (CDM, 1982b) and the Safe Drinking Water guideline (USEPA, 2001) based on average chloride concentrations from January 1973 to December 1979.

Subbasin	Parabasal Range (<30 mg/l)	Saltwater Toe Range (30 to 70 mg/l)	Basal Range (>70 to <150 mg/l)	At or Over Saltwater Upconing Benchmark (150 to 250 mg/l)	Over SDW Guideline (>250 mg/l)
Agana	↑ A-1 ↑ A-2 A-3 ↑ A-4 ↑ A-5 ↑ A-6 ↑ A-7 A-8 A-11 A-12		A-15	A-9 ↑ A-10 ↑ A-14 ↑ A-18 ↑ A-21	↑ A-13 A-16 ↑ A-17 ↑ A-19
Yigo	D-12 ↑ Y-1 ↑ Y-2 ↑ Y-3 ↑ Y-4 ↑ D-17	↑ D-1 ↑ D-2 D-3 D-4 D-5 ↑ D-6 ↑ D-7 D-10 ↑ D-14 ↑ M-5 ↑ M-6 ↑ M-7 M-12 ↑ M-14 ↑ Y-5	↑ D-8 ↑ D-9 ↑ D-11 ↑ D-15 ↑ D-16		D-13 M-11
Finegayan	↑ AG-2 ↑ F-8	↑ F-7	↑ F-1 ↑ F-2 F-3 ↑ F-4 ↑ F-5 ↑ F-6 F-9 ↑ F-10 ↑ F-11 ↑ H-1		
Mangilao	↑ M-3 ↑ M-4 ↑ M-8		↑ M-1 ↑ M-2	↓ M-9	
Andersen					
Agafa Gumas		↑ AG-1			

↑: Statistically increasing chloride concentrations over the entire period of record.

↓: Statistically decreasing chloride concentrations over the entire period of record.

No arrow sign indicates that chloride concentrations did not exhibit a significant linear trend over the entire period of record.

Table 4. Wells within each chloride benchmark category (CDM, 1982b) and the Safe Drinking Water guideline (USEPA, 2001) based on average chloride concentrations from January 1980 to December 1989.

Subbasin	Parabasal Range (<30 mg/l)	Saltwater Toe Range (30 to 70 mg/l)	Basal Range (>70 to <150 mg/l)	At or Over Saltwater Upconing Benchmark (150 to 250 mg/l)	Over SDW Guideline (>250 mg/l)
Agana	↑ A-1 ↑ A-2 A-3 ↑ A-4 ↑ A-5 ↑ A-6 ↑ A-7 A-8 A-11 A-12 ↑ A-23 ↑ A-25 ↑ A-31		A-26	A-9 ↑ A-10 A-15 ↑ A-28	↑ A-13 ↑ A-14 ↑ A-17 ↑ A-18 ↑ A-19 ↑ A-21
Yigo	↑ Y-1 ↑ Y-2 ↑ Y-3 ↑ Y-4 Y-6 Y-7 ↑ Y-9 Y-10	↑ D-1 ↑ D-2 D-3 D-4 D-5 ↑ D-6 ↑ D-7 D-10 D-12 ↑ D-14 ↑ D-17	D-19 D-20 ↑ EX-5A ↑ M-5 ↑ M-7 ↑ M-14 M-15 M-17B M-18 ↑ Y-5	↑ D-9 ↑ D-11 ↑ D-15 ↑ D-16 ↑ D-18 D-21 ↑ GH-501 ↑ M-6 ↑ M-12 M-17A	↑ D-8 D-13
Finegayan	↑ AG-2 ↑ F-8	↑ F-5 ↑ F-7 F-9	↑ F-1 ↑ F-2 F-3 ↑ F-4 ↑ F-11 ↑ H-1	↑ F-6 ↑ F-10	
Mangilao	↑ M-3 ↑ M-4 ↑ M-8	↑ EX-11 M-16B	↑ M-2	↑ M-1 ↓ M-9	
Andersen					
Agafa Gumas		↑ AG-1			

↑: Statistically increasing chloride concentrations over the entire period of record.

↓: Statistically decreasing chloride concentrations over the entire period of record.

No arrow sign indicates that chloride concentrations did not exhibit a significant linear trend over the entire period of record.

Table 5. Wells within each chloride benchmark category (CDM, 1982b) and the Safe Drinking Water guideline (USEPA, 2001) based on average chloride concentrations from January 1990 to December 1999.

Subbasin	Parabasal Range (<30 mg/l)	Saltwater Toe Range (30 to 70 mg/l)	Basal Range (>70 to <150 mg/l)	At or Over Saltwater Upconing Benchmark (150 to 250 mg/l)	Over SDW Guideline (>250 mg/l)
Agana	↑ A-1 ↑ A-2 A-3 ↑ A-5 ↑ A-6 ↑ A-7 A-8 A-11 A-12 A-32 ↑ NRMC-1	↑ A-4 ↑ A-23 ↑ A-25 A-29 ↑ A-31 NRMC-3	A-15 A-26 A-30 NCS-3 ↓ NCS-8 ↑ NRMC-2	A-9 ↑ A-28	↑ A-10 ↑ A-13 ↑ A-14 ↑ A-17 ↑ A-18 ↑ A-19 ↑ A-21
Yigo	D-12 D-27 ↑ Y-1 ↑ Y-2 ↑ Y-3 ↑ Y-4 Y-4A Y-6 Y-7 ↑ Y-9 Y-18 Y-19 Y-20	↑ D-1 ↑ D-2 D-3 D-4 D-5 ↑ D-6 ↑ D-7 D-10 ↑ D-14 D-19 D-20 D-25 D-28	↑ EX-5A ↑ M-5 ↑ M-7 ↑ M-14 M-15 M-17B M-18 ↓ M-20A M-21 ↑ Y-5 Y-10 Y-12 Y-14	↑ D-11 ↑ D-15 ↑ D-16 ↑ D-18 D-26 ↑ GH-501 ↑ M-6 ↑ M-12 M-17A	↑ D-8 ↑ D-9 ↑ D-17 D-13
Finegayan	↑ AG-2 ↑ F-8 ↑ F-12 F-16 F-17 F-18 HGC-2	D-22A D-24 F-9 F-15 ↓ NCS-6 NCS-7	D-21 ↑ F-1 ↑ F-2 F-3 ↑ F-5 ↑ F-7 ↑ F-11 ↑ F-19 F-20 ↑ H-1 ↓ NCS-2 NCS-9A NCS-B	↑ F-4 ↑ F-6 ↑ F-10 F-13 ↓ NCS-5 NCS-A	
Mangilao	↑ M-3 ↑ M-4 ↑ M-8	↑ EX-11 M-16B	↑ M-2	↑ M-1 ↓ M-9	
Andersen	Y-15				
Agafa		↑ AG-1			

↑: Statistically increasing chloride concentrations over the entire period of record.

↓: Statistically decreasing chloride concentrations over the entire period of record.

No arrow sign indicates that chloride concentrations did not exhibit a significant linear trend over the entire period of record.

5.1.2 Chloride histories of problem wells

The chloride histories of wells with average chloride concentrations that exceeded the CDM (1982b) saltwater upconing benchmark (150 mg/l) and the SDW guideline (250 mg/l) are shown in Table 6 and Figure 11. From January 1973 through December 1979, six wells—A-9, 10, 14, 18, 21 and M-9—out of the extant 68 study wells (i.e., the 68 wells for which data were collected over during the decade and that were therefore examined in this study) exhibited average concentrations from greater than 150 to 250 mg/l (Figure 8 and Table 3). Six other wells exhibited average chloride levels greater than 250 mg/l: A-13, 16, 17, 19, D-13, and M-11. A-16 and M-11 were shut down and converted to observation wells (Mink, 1976) by the end of the decade because their high chloride concentrations.

Table 6. Wells exceeding the saltwater upconing benchmark (150 mg/l) and Safe Drinking Water guideline (250 mg/l) for chloride concentrations during the 1970s, 1980s, and 1990s.

Interval	Number of Study Wells	Average Chloride Concentration	
		150 through 250 mg/l	greater than 250 mg/l
1/1973 through 12/1979	68	A-9, A-10, A-14, A-18, A-21, M-9 (6 wells)	A-13, A-16, A-17, A-19, D-13, M-11 (6 wells)
1/1980 through 12/1989	87	A-9, A-10, A-15, A-28, D-8, F-6, F-10, M-1, M-9 (9 wells)	A-13, A-14, A-17, A-18, A-19, A-21, D-13 (7 wells)
1/1990 through 12/1999	126	A-9, A-28, D-8, D-9, D-17, F-4, F-6, F-10, F-13, M-1, M-9, NCS-A, NCS-5 (13 wells)	A-10, A-13, A-14, A-17, A-18, A-19, A-21, D-13 (8 wells)

Of the 87 study wells extant by the end of the 1980s (Figure 9 and Table 4), 9 had chloride between the 150 mg/l upconing benchmark and the 250 mg/l SDW guideline. Wells A-9, A-10, and M-9 maintained average chloride above 150 mg/l. Averages at A-15, D-8, F-6, F-10, and M-1 were below 150 mg/l in the 1970s but rose over this benchmark in the 1980s. Well A-28 began operation in 1983 with chloride over 150 mg/l. The number of wells with chloride concentrations over the SDW guideline increased from 6 wells in the 1970s to 7 in the 1980s. Wells A-13, A-17, A-19, and D-13 maintained average chloride over 250 mg/l from the 1970s, while averages at A-14, A-18, and A-21, which had been below the SDW guideline in the 1970s, climbed over 250 mg/l in the 1980s.

More wells were drilled in the 1990s, bringing the number on line to 126 (Figure 10 and Table 5). Thirteen exhibited average chloride between 150 and 250 mg/l during this decade. Wells A-9, A-28, D-8, F-6, F-10, M-1, and M-9 maintained previous averages over 150 mg/l. At wells F-4 and D-9, average chloride concentrations had been below 150 mg/l in the 1980s, but rose to exceed 150 mg/l in the 1990s. Wells D-17, F-13, NCS-A, and NCS-5 began operations in the 1990s with average levels over 150 mg/l. A-15's chloride average, which was over 150 mg/l in the 1980s, dropped below this benchmark in the 1990s. Eight wells had chloride averages greater than 250 mg/l. Wells A-13, A-14, A-17, A-18, A-19, A-21, and D-13 maintained previous averages over 250 mg/l (Figure 11). Well A-10's average, which had been below the 250 mg/l SDW guideline in the 1980s, rose above it in the 1990s.

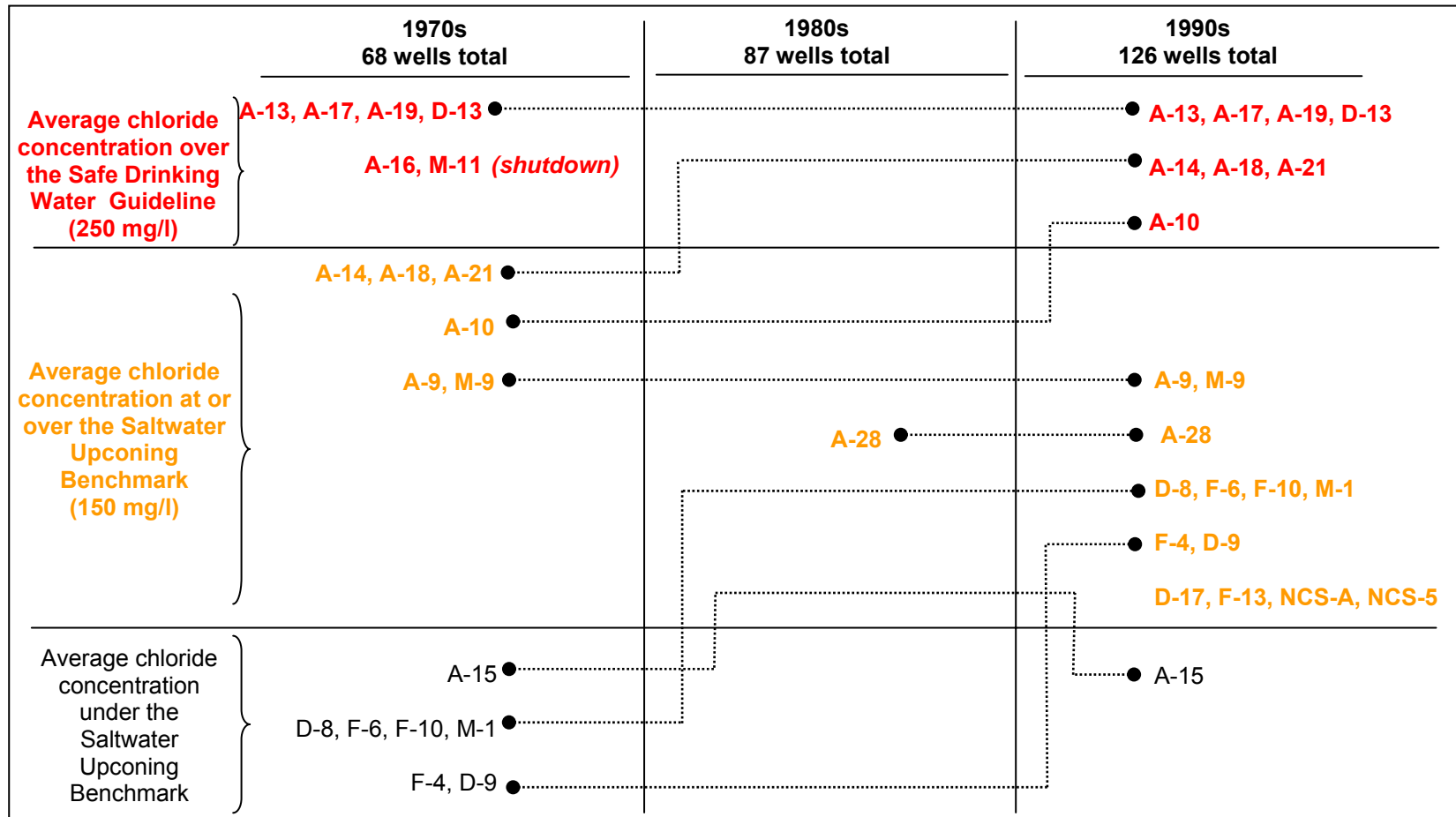

Figure 11. Diagram of high chloride wells showing changing average chloride concentrations in the 1970s, 1980s, and 1990s.

5.2 Chloride trends and probable causes

Temporal trends exhibited by the regressions and decadal averages of chloride concentrations over the past three decades can be characterized in terms of three general patterns. Wellhead chloride concentrations either:

1. stayed within an original chloride category (i.e., between benchmarks),
2. increased sufficiently to cross into a higher category, or
3. started and stayed high, i.e., above the 150 mg/l saltwater upconing benchmark or the 250 mg/l SDW guideline.

Wells that started with good quality water and exhibited only gradual increases of relatively small magnitude, have generally been constructed and managed according to design and pumping rate recommendations (e.g., CDM recommendations in the NGLS). Some general increase in chloride concentrations across well fields can be expected as the portion of the lens from which water is being extracted equilibrates to the new water balance imposed by the extraction (Todd, 1980). Continued monitoring—and where practical, computer modeling of the aquifer response to the extraction—can help predict whether slow upward trends will persist or whether they simply indicate that the aquifer is in transition from the original conditions to conditions in equilibrium with the engineering design. In the latter case, the trend should flatten out if there are no further increases in extraction and reduction in long-term average recharge. Although 64 of the 128 wells in this study exhibited statistically increasing chloride levels, the rates of change did not suggest that chloride concentrations were rising more rapidly than might be expected for a well field that is generally equilibrating to the development.

For wells with histories fitting the second pattern (i.e., chloride concentrations increasing at sufficient rate and magnitude to cross a benchmark) we looked more closely at the record. Wells where chloride concentrations climb rapidly after the start of operation are almost certain to have been drilled too deep, pumped too hard, or both. Wells that maintained acceptable chloride levels for years but then exhibited sudden increases may have been designed and managed properly until the pumping rate was increased excessively, or may have responded to interference from subsequent additional wells installed too close, or to some diversion of recharge that previously went to the well. For this second group of wells, chloride levels may be brought down by reducing the pumping rate of the well or nearby wells, or shutting the well or nearby wells down for long enough to allow the lens to recover. However, if the well has been drilled so deep that it penetrates into the transition zone, reducing the pumping rate may not suffice for long-term recovery.

Wells fitting the third pattern (wells that produce high chloride water from the start of their operations) are almost certain to have been designed or installed improperly at the beginning. Such wells were probably drilled much too deep, terminating in the saltwater transition zone. For these wells, no pumping rate will be sufficiently low to obtain water with desired low chloride concentrations. The only remedy is to close the well and install a new well in an unaffected area.

Chloride conditions and probable causes for high chloride concentrations are discussed in the following sections for the NGLA subbasins (Figure 3). The Agana Subbasin is discussed first because it exhibits both the highest incidence and highest levels of chloride. The Yigo Subbasin, which is the highest producing subbasin, is discussed next. The Finegayan and Mangilao Subbasins are discussed next based on the volume of groundwater extraction from each area. The Agafa Gumás and Andersen Subbasins were not analyzed because they have yet to be developed. Each of these subbasins contains only a single well with chloride concentrations within original chloride ranges.

5.3 Agana Subbasin

5.3.1 History of chloride concentrations at production wells

Although the Agana Subbasin contains a number of parabasal wells with low chloride, it also contains wells with the highest chloride concentrations in the NGLA (Figure 12). The histories of these wells are diagrammed in Figure 11. In the 1970s, 5 wells—A-9, A-10, A-14, A-18, and A-21—had average chloride over the saltwater upconing benchmark, while 4 wells—A-13, A-16, A-17, and A-19—had average chlorides over the SDW guideline. A-16 was shut down because of its high chloride. In 1975, a letter from GEPA to the Public Utility Agency of Guam (Natarajan, 1975) recommended reduction or cessation of production at A-17 and A-19 due to high chloride levels, but both remain in operation.

During the 1980s, A-9 and A-10 maintained averages above 150 mg/l, while A-28 began operation over this benchmark. Average chloride at A-15 rose above the saltwater upconing benchmark in the 1980s. Chloride concentrations at A-13, A-17, and A-19 remained over the SDW guideline in the 1980s, while averages at A-14, A-18, and A-21 rose above 250 mg/l in the during this decade.

Chloride averages at A-9 and A-28 continued to exceed the saltwater upconing benchmark through the 1990s. Well A-10's average, which was below the SDW guideline in previous years, rose over 250 mg/l in the 1990s. Average chloride concentrations at wells A-13, A-14, A-17, A-18, A-19, and A-21 remained over the SDW guideline. Average 1990s chloride concentrations of the Agana Subbasin wells and their temporal trends over their complete chloride records are listed in Table 7.

5.3.2 Probable causes of chloride concentrations over 150 mg/l

Average chloride levels, production rates, and well termination depths for wells with chloride over 150 mg/l are shown in Figure 13. The Appendix, taken from McDonald (2001, Appendix I) contains the same data for all the wells in the subbasin. Average production increased considerably from the 1980s to the 1990s at wells A-9, A-10, A-13, A-14, A-17, A-18, A-19, and A-21, while average chloride rose substantially. Pumping rates thus appear to be a major contributor to high chloride levels at these wells. However, A-28's average chloride decreased from the 1980s to the 1990s in spite of a production rate increase between the two decades. The cause of A-28's chloride decrease is unknown and warrants further investigation, although it's initial high chloride levels are probably due to an excessive pumping rate.

Excessive termination depths also clearly contributed to chloride concentrations. According to USGS drilling records, A-19 was backfilled to 10 ft above its original depth—44 ft below mean sea level (msl)—in 1975, two years after it was drilled. However, chloride levels were not relieved. Either the pumping rate after backfilling was not appropriate for aquifer conditions, the well wasn't backfilled enough, or backfilling was not effective at this location (backfilling does not regain original geologic conditions below the elevated bottom of the borehole, and thus alters vertical groundwater flow). A-13 was also backfilled (from 287 to 194 ft below msl) soon after it was drilled, but it was cased in cement from 57 ft below msl to the surface, limiting the well to extracting water close to the salt/freshwater interface. A-13's final state is extreme when considering that chloride concentrations of 250 mg/l can be expected at depths as shallow as 35 ft below msl at neighboring observation well EX-4 (Figure 14).

Chloride profiles at EX-4 also indicate that the depths of other wells may contribute to chloride levels over 150 mg/l. A well would have to terminate no deeper than 25 ft below msl to avoid tapping groundwater with a natural chloride concentration of 150 mg/l (Figure 14). The inefficiency of wells A-9, A-10, and A-19 may be compounded by the existence of voids in their boreholes, (reported in drilling logs) which may affect groundwater flow to the well.

Management practices can also contribute to increasing chloride levels. The high chloride wells were drilled in Agana Argillaceous Limestone, which has a low regional hydraulic conductivity that contributes to large drawdown at production wells. Although it is unknown if the high chloride wells'

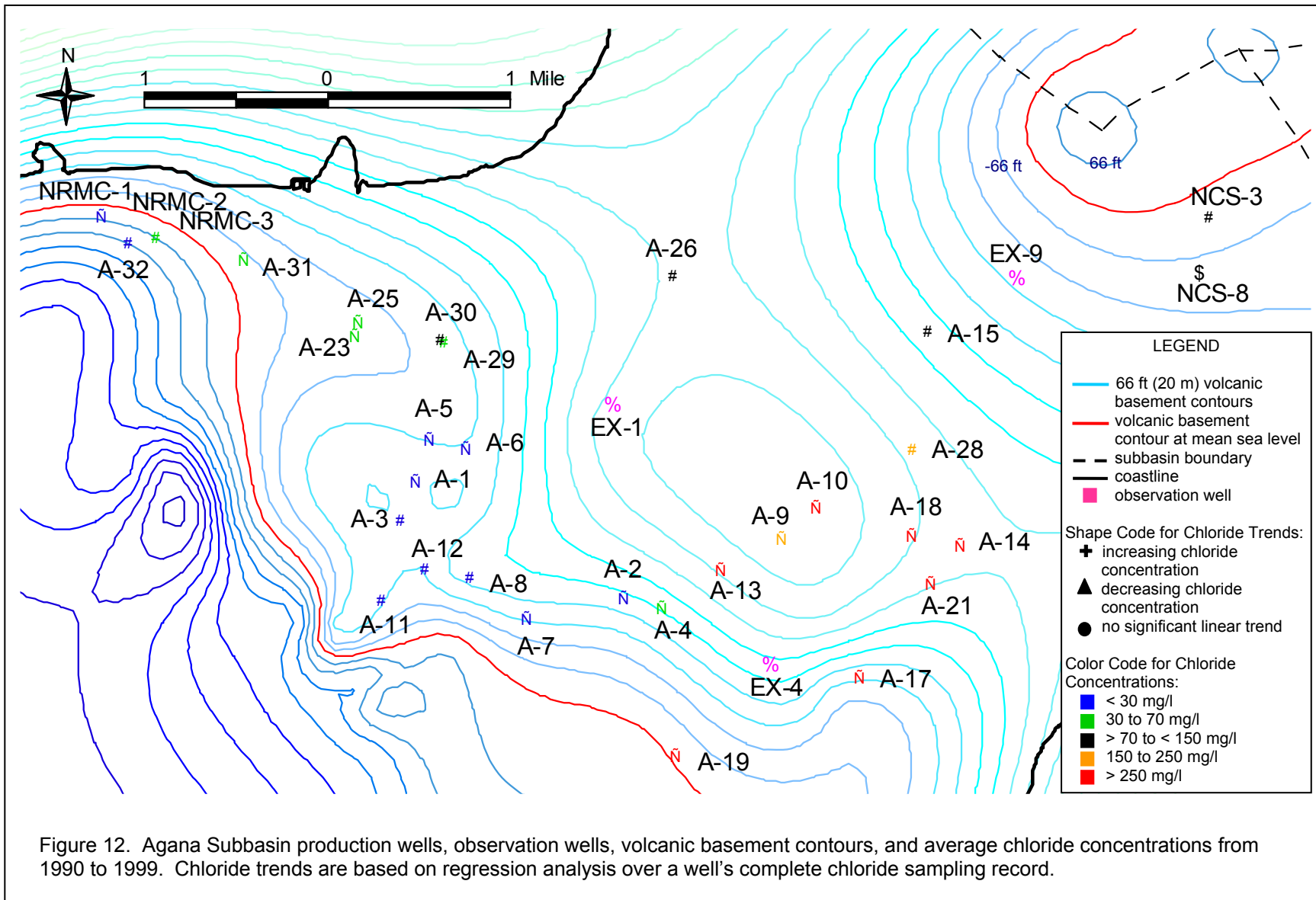

Table 7. Agana Subbasin production wells in chloride benchmark categories based on average chloride concentrations in the 1990s.

Original Parabasals Range (<30 mg/l)	Original Saltwater Toe Range (30 to 70 mg/l)	Original Basal Range (>70 to <150 mg/l)	Over Saltwater Upconing Benchmark (150 mg/l to 250 mg/l)	Over SDW Guideline (>250 mg/l)
↑ A-1	↑ A-4	A-15	↑ A-9	↑ A-10
↑ A-2	↑ A-23	A-26	A-28	↑ A-13
A-3	↑ A-25	A-30		↑ A-14
↑ A-5	A-29	NCS-3		↑ A-17
↑ A-6	↑ A-31	↓ NCS-8		↑ A-18
↑ A-7	NRMC-3	↑ NRMC-2		↑ A-19
A-8				↑ A-21
A-11				
A-12				
A-32				
↑ NRMC-1				

↑: Statistically increasing chloride concentrations over the entire period of record

↓: Statistically decreasing chloride concentrations over the entire period of record

No arrow sign indicates that chloride concentrations did not exhibit a significant linear trend over the entire period of record

radii of influence intersect, the cones of depression of neighboring wells may become superimposed, having an additive effect in lowering the local water table (Linsley et al., 1986), as shown in Figure 15.

5.3.3 Saltwater intrusion

Saltwater upconing in the Agana Subbasin seems to have been isolated to the southwestern area. Based on CDM's (1982b) saltwater intrusion benchmark, chloride ion concentrations at A-9, A-10, A-13, A-14, A-17, A-18, A-19, and A-21 suggest that these wells induced saltwater upconing in the 1970s and maintained this condition through 1999. A-28 appears to have induced saltwater upconing soon after it started operating in 1983. Data from observation wells EX-4, EX-1, and EX-9 (Figures 14, 16, and 17) did not conclusively prove regional saltwater intrusion. Chloride concentrations at the topmost portions of the lens were stable with the 30 mg/l isochlor generally located above 14 ft below msl at EX-1 and EX-4. However, the depths of intermediate chloride concentrations were much more variable. The depths of 70 mg/l ranged from 11 to 207 ft below msl at EX-4 and from 8 ft to 204 ft below msl at EX-1, while the 150 mg/l isochlor varied from 19 to 216 ft below msl at EX-4 and from 19 to 205 ft below msl at EX-1 (McDonald, 2001, Appendix D).

Interpolated depths of the 50% isochlor (9,500 mg/l) fluctuated between 243 and 289 ft below msl at EX-1, between 221 and 235 ft below msl at EX-4, and between 114 and 131 ft below msl at EX-9 (McDonald, 2001, Appendix D). Linear regression of the 50% isochlor depths for EX-1 and EX-4 were inconclusive while EX-9 had an increasing trend at an alpha level of 0.05 (McDonald, 2001, Appendix J). However, the rising trend of EX-9's 50% isochlor depth does not necessarily signal the occurrence of regional saltwater intrusion and more profiling is needed to make this determination.

Although chloride profiles do not conclusively indicate regional saltwater intrusion, NRMC-2 and NRMC-3's chloride concentrations raise some concern. The two wells were drilled in the 1990s in what should be a parabasal area, according to revised basement volcanic contours (Figure 12). However, their chloride levels fluctuate above the original parabasal range due to either the wells causing immediate inland movement of the saltwater toe or that they were in actuality drilled into saltwater toe or basal water. In either case, NRMC-2's depth (89 ft below msl) seems excessive.

Rising chloride levels at A-4, A-23, A-25, and A-31 may suggest inland movement of the saltwater toe, a condition consistent with regional saltwater intrusion. An increase in average production rates from the 1980s to the 1990s at wells A-4, A-23, and A-25 (see Appendix from McDonald, 2001, Appendix I) may be responsible for an increase in average chloride concentrations from the 1980s to the 1990s. Additionally, A-4 was originally drilled to 289 ft below msl and was back-filled (i.e., filled with

concrete or aggregate) to 189 ft below msl, a depth that is still very deep. A-25, which was drilled to 106 ft below msl, also seems unnecessarily deep.

	Decade	A-9	A-10	A-13	A-14	A-17	A-18	A-19	A-21	A-28
average chloride concentration (mg/l)	1970s	155	190	270	238	275	224	288	204	--
	1980s	162	208	310	288	309	289	275	267	187
	1990s	182	287	371	295	355	390	353	351	172
% change (1970s-1980s)		+5%	+9%	+15%	+21%	+12%	+29%	-5%	+31%	--
% change (1980s-1990s)		+12%	+38%	+20%	+2%	+15%	+35%	+28%	+31%	-8%
average production rate (gpm)	1980s	175	184	173	179	168	162	119	170	189
	1990s	214	211	230	209	216	207	175	199	227
% change (1980s-1990s)		+22%	+15%	+33%	+17%	+29%	+28%	+47%	+17%	+20%
probable cause of chloride concentrations		depth and pumping rate	depth and pumping rate	depth and pumping rate	depth and pumping rate	depth and pumping rate	depth and pumping rate	depth and pumping rate	depth and pumping rate	depth and pumping rate

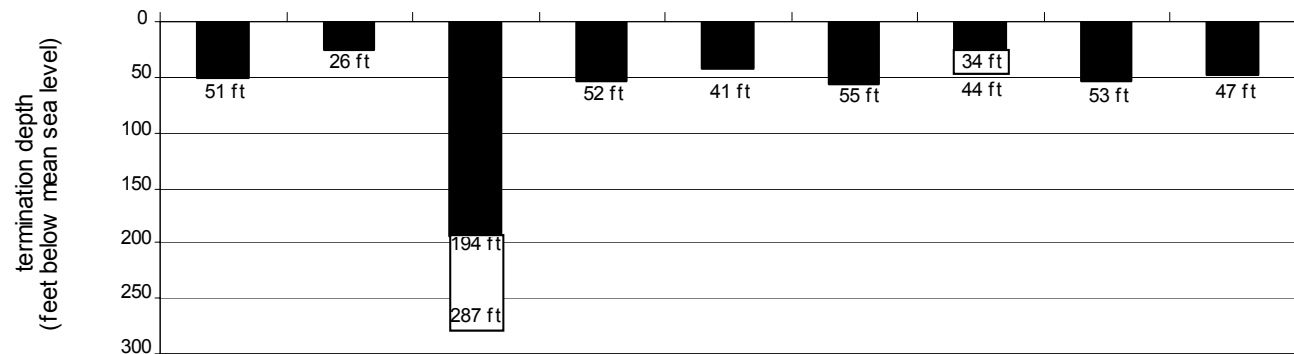

Figure 13. Average chloride concentrations, average monthly production rates, and well termination depths of Agana Subbasin wells with chloride concentrations over the saltwater upconing benchmark.

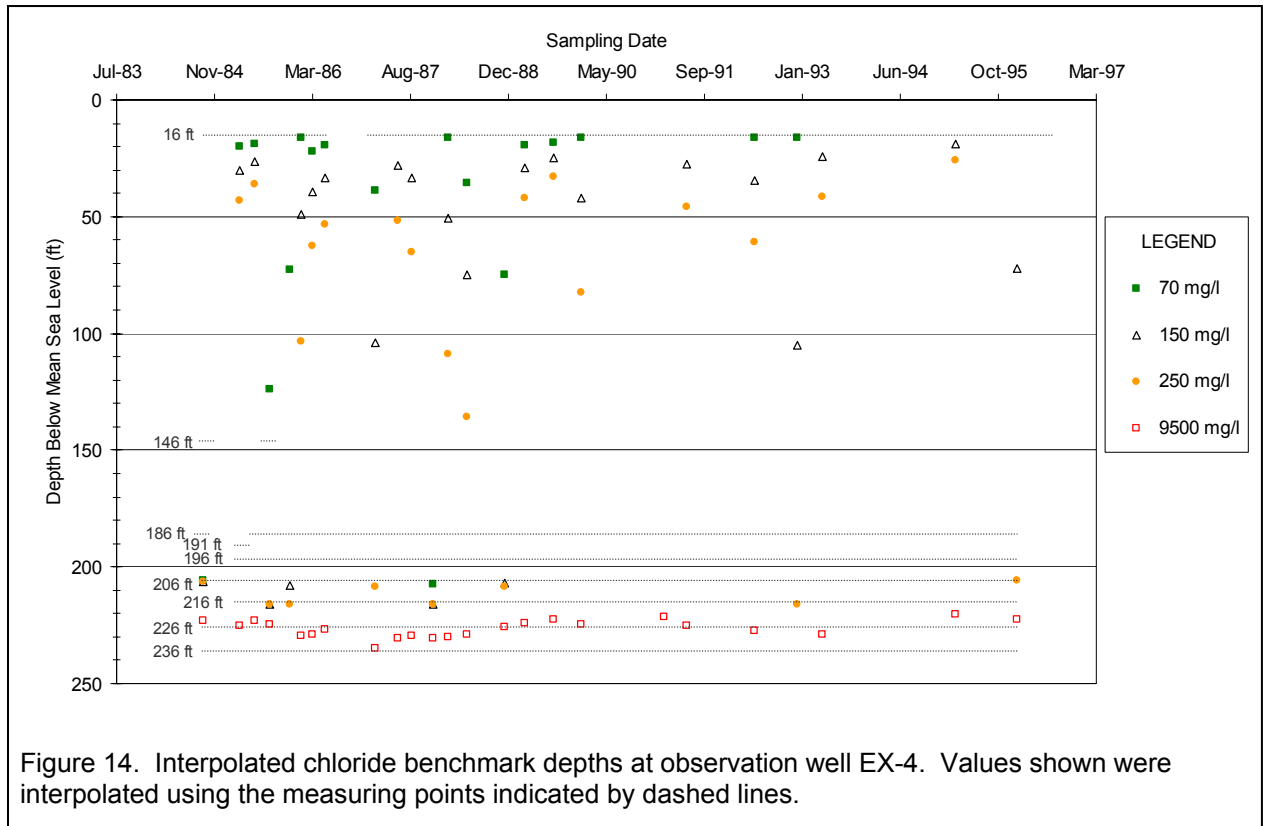

Figure 14. Interpolated chloride benchmark depths at observation well EX-4. Values shown were interpolated using the measuring points indicated by dashed lines.

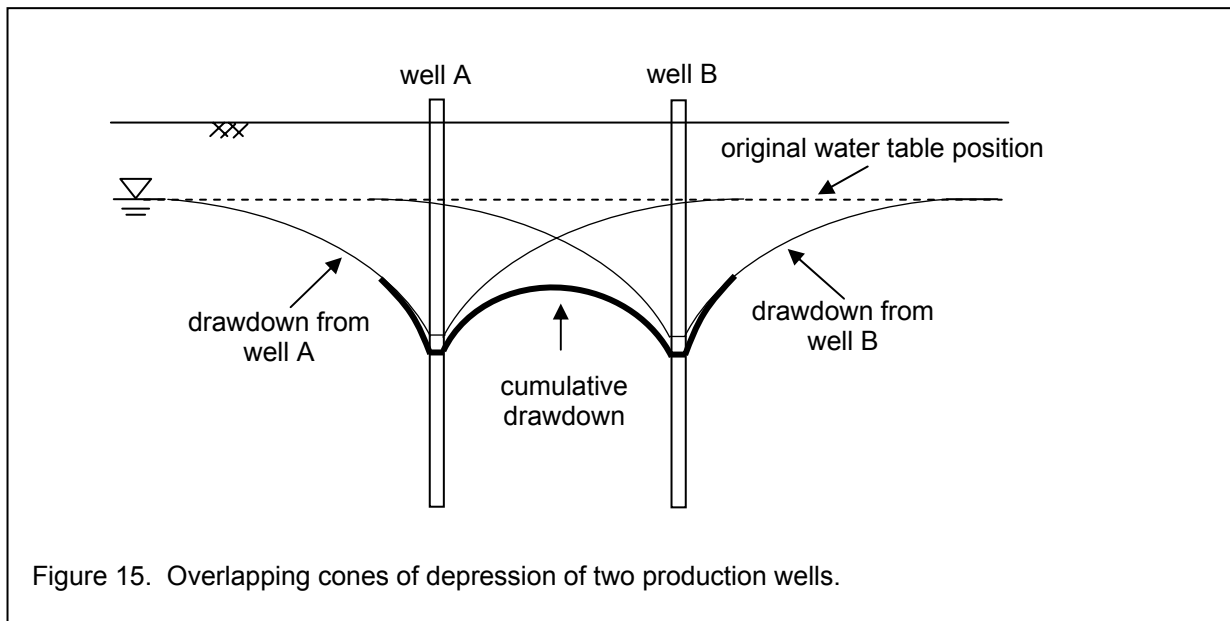

Figure 15. Overlapping cones of depression of two production wells.

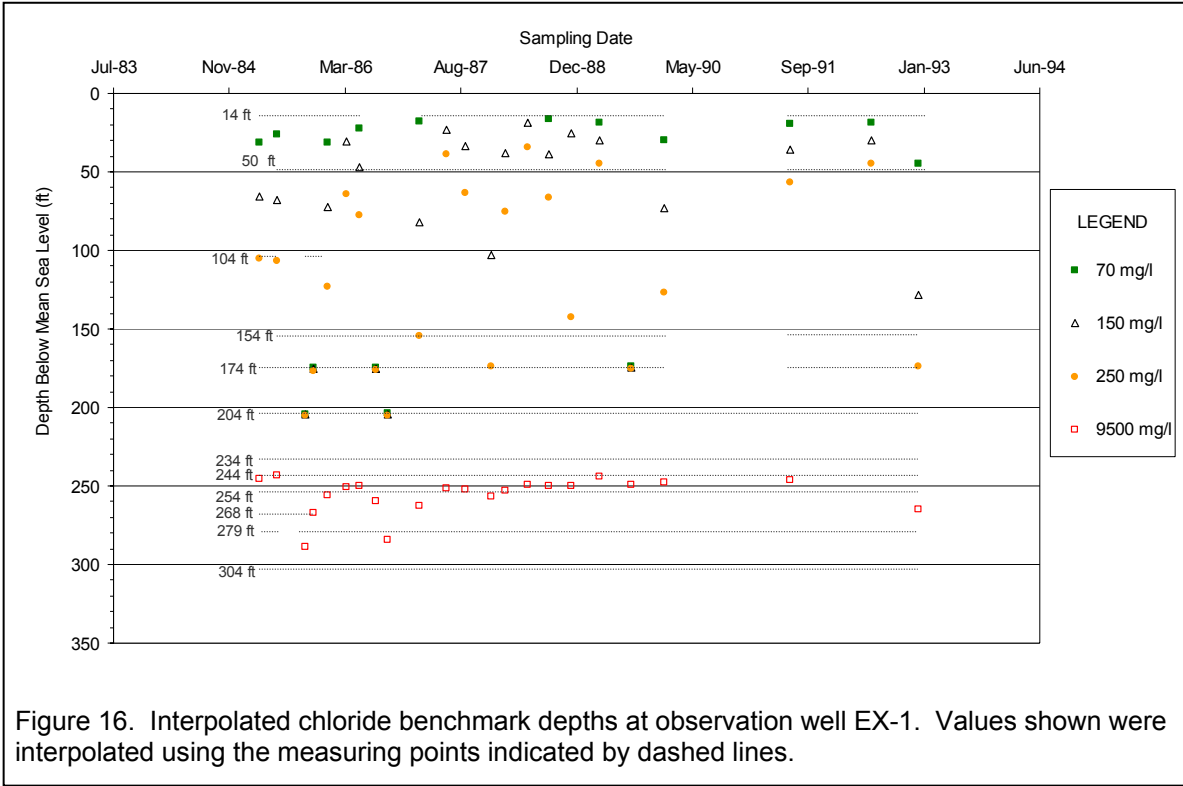

Figure 16. Interpolated chloride benchmark depths at observation well EX-1. Values shown were interpolated using the measuring points indicated by dashed lines.

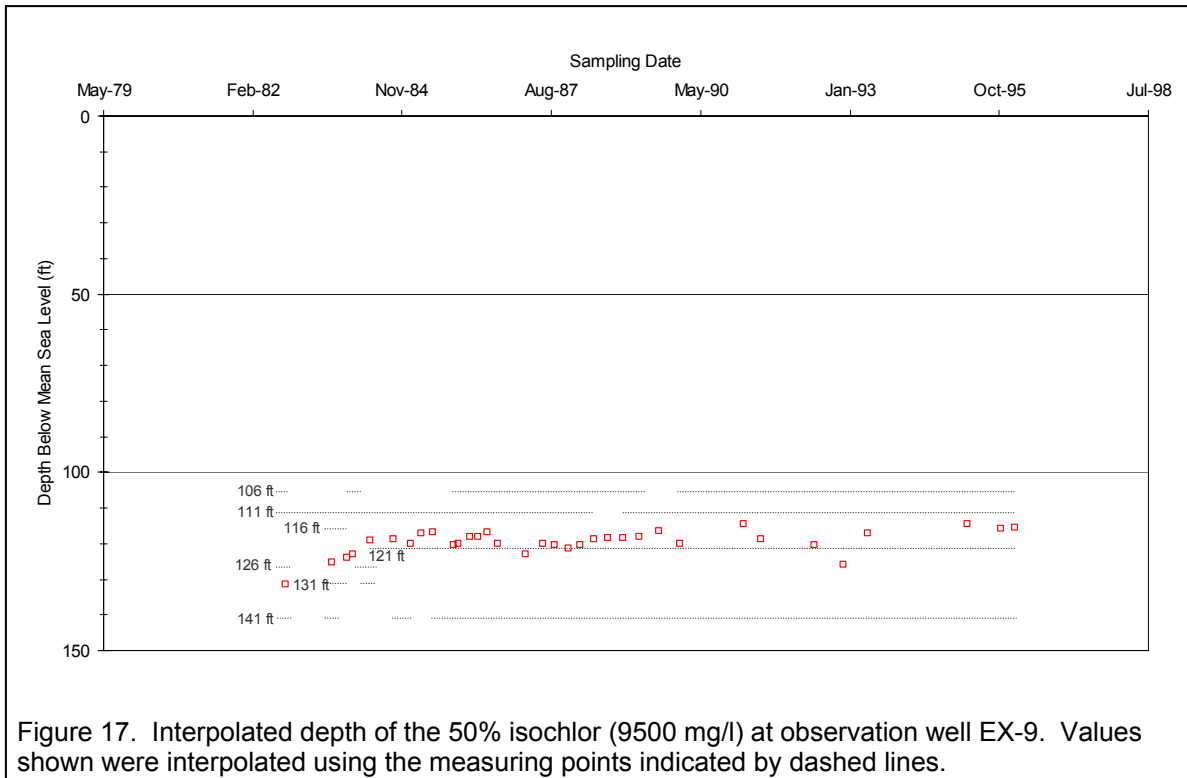

Figure 17. Interpolated depth of the 50% isochlor (9500 mg/l) at observation well EX-9. Values shown were interpolated using the measuring points indicated by dashed lines.

5.4 Yigo Subbasin

5.4.1 *History of chloride concentrations at production wells*

Chloride histories for each well in the Yigo Subbasin are mapped in Figure 18 and listed in Table 8. The Yigo Subbasin is the NGLA's highest producing subbasin, and water quality has historically been very good. By the 1990s, the Yigo Subbasin contained 52 wells, only four of which produced high chloride water. Well D-13 averaged over 250 mg/l from the 1970s through the 1990s (Figure 11). Three others—D-8, D-9, and D-17—exceeded the saltwater upconing benchmark in the 1990s. In the 1980s, the average chloride at well D-8, which had previously been below 150 mg/l, rose above the benchmark and continued to average above 150 mg/l thereafter. Average chloride at D-9, which had been below 150 mg/l from the 1970s through the 1980s, rose above the saltwater upconing benchmark during the 1990s. D-17 began operation in the 1990s above 150 mg/l.

5.4.2 *Probable causes of chloride concentrations over 150 mg/l*

Production rates, chloride averages, and termination depths of wells with chloride over the saltwater upconing benchmark are shown in Figure 19. The Appendix (McDonald, 2001, Appendix I) contains the same data for all wells in the subbasin. During the 1970s, wells D-8 and D-9 had 1970s chloride averages below the saltwater upconing benchmark, suggesting that 1970s pumping rates were appropriate for well depths. Production rate increases appear to account for chloride increases after the 1970s. D-8's average monthly production rate was increased by 41% (from 137 to 193 gpm) in the 1990s, corresponding to a 41% increase (from 160 to 225 mg/l) in average chloride between 1980s and 1990s. Well D-9's production rate increased by 13% (from 168 to 190 gpm) from the 1980s to the 1990s, coinciding with a 12% increase in chloride (from 136 to 152 mg/l), which pushed the well over the saltwater upconing benchmark.

The trend in chloride concentrations and correlation with pumping rate at D-17 is dramatic. In the 1970s, D-17 produced excellent quality water, with chloride below 30 mg/l. The average chloride concentration rose above 30 mg/l in the 1980s. Data from nearby observation well EX-7 (Figure 20) show that the lens actually thickened after August 1987, which should have been reflected in lower chloride levels at D-17. Instead, the average chloride at D-17 increased by 157% (from 70 mg/l to 180 mg/l) from the 1980s to the 1990s, corresponding to 33% increase in average production rate (from 149 to 198 gpm.). Thus the effects of the pumping rate increase apparently overwhelmed whatever effect that thickening of the lens may have had at D-17.

D-13 had the highest chloride concentrations in the Yigo Subbasin and consistently produced water over the SDW guideline from the 1970s to the 1990s. Mink (1976; 1991) attributed D-13's extreme chloride levels to its depth and location and speculated that the well was drilled in an area where "vertical permeability exceeds horizontal permeability so that deeper water from the transition zone is drawn to the well under pumping stress." In 1975 the Guam EPA recommended that D-13's production be halved, and then shut down if chloride concentrations did not improve (Natarajan, 1975). Instead, the well was back-filled 25 ft in 1975 (according to USGS drilling records), raising the termination depth to 27 ft below msl. A year later Mink recommended the well be shut down. However, well operations continued and the production rate increased an additional 9% (from 149 to 163 gpm) from the 1980s to the 1990s.

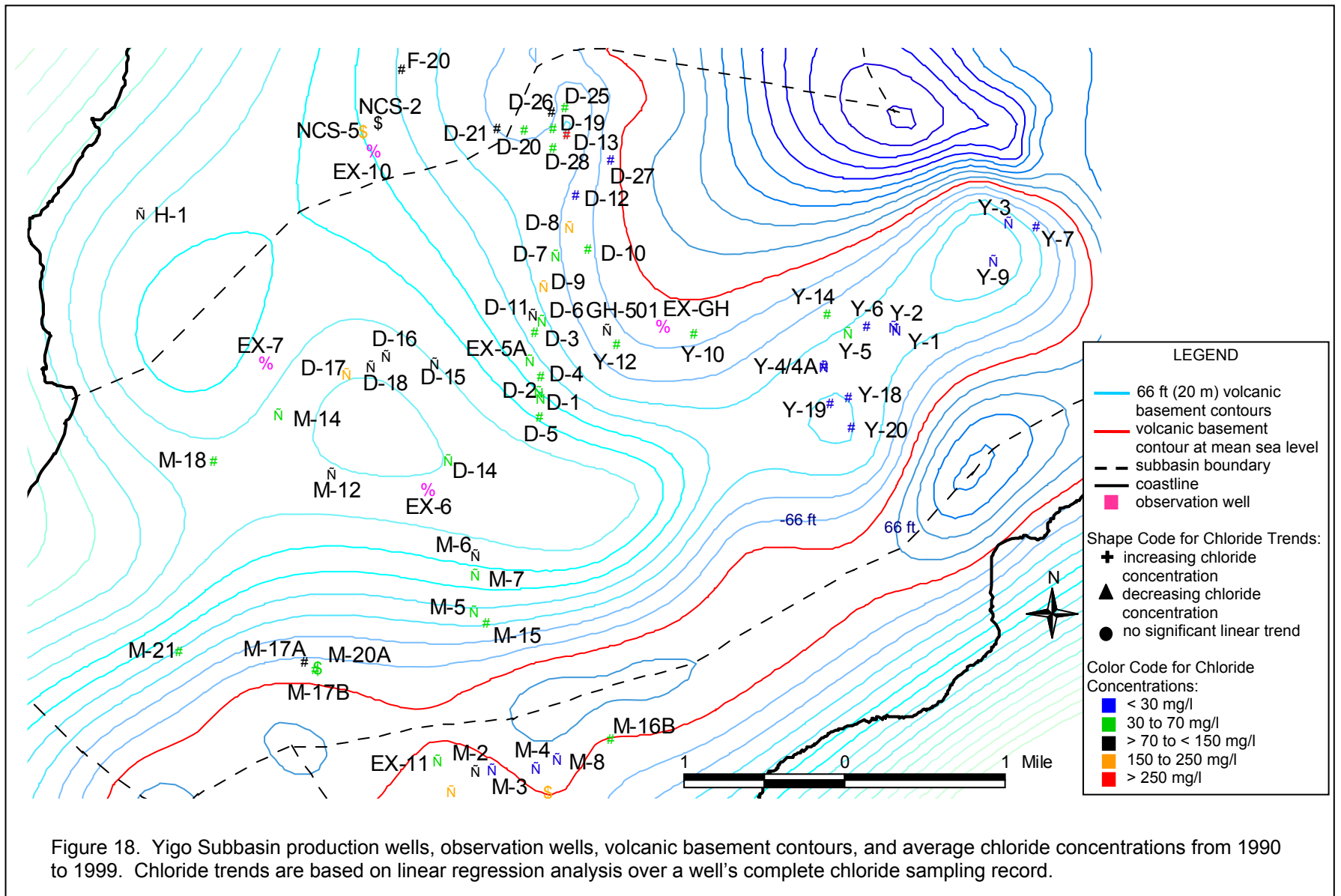

Table 8. Yigo Subbasin production wells in chloride benchmark categories based on average chloride concentrations in the 1990s.

Parabasal Range (<30 mg/l)	Saltwater Toe Range (30 to 70 mg/l)	Basal Range (>70 to <150 mg/l)	Over Saltwater Upconing Benchmark (150 mg/l to 250 mg/l)	Over SDW Guideline (>250 mg/l)
D-12	↑ D-1	↑ D-11	↑ D-8	D-13
D-27	↑ D-2	↑ D-15	↑ D-9	
↑ Y-1	D-3	↑ D-16	↑ D-17	
↑ Y-2	D-4	↑ D-18		
↑ Y-3	D-5	D-26		
↑ Y-4	↑ D-6	↑ GH-501		
Y-4A	↑ D-7	↑ M-6		
Y-6	D-10	↑ M-12		
Y-7	↑ D-14	M-17A		
↑ Y-9	D-19			
Y-18	D-20			
Y-19	D-25			
Y-20	D-28			
	↑ EX-5A			
	↑ M-5			
	↑ M-7			
	↑ M-14			
	M-15			
	M-17B			
	M-18			
	↓ M-20A			
	M-21			
	↑ Y-5			
	Y-10			
	Y-12			
	Y-14			

↑: Statistically increasing chloride concentrations over the entire period of record

↓: Statistically decreasing chloride concentrations over the entire period of record

No arrow sign indicates that chloride concentrations did not exhibit a significant linear trend over the entire period of record

5.4.3 Saltwater intrusion

Lens health in the Yigo Subbasin seemed good in the 1990s, in spite of apparent saltwater upconing at D-8, D-9, D-13, and D-17. Profiles from observation wells EX-7, EX-6, and EX-Ghura Dededo (Figures 20, 21, and 22) indicate that the thickness of the portion of the lens with chloride less than 250 mg/l increased dramatically in the late 1980s (with the interpolated 250 mg/l isochlor descending from about 30 to over 100 ft below msl at EX-7) though the cause for this is unknown. The depth of the 50% isochlor, on the other hand, appears to have remained nearly constant. Variability of the 50% isochlor depth was greater at EX-7, which is closer to the coast than the other two observation wells, fluctuating between 101 and 143 ft below msl. (Variability may have also increased after 1987.) Further inland at EX-6 and EX-Ghura Dededo, the depths of the 50% isochlor had 15 and 13 ft ranges, respectively. Linear regressions of 50% isochlor depths at all three observation wells did not show a significant temporal trend at an alpha level of 0.05 (McDonald, 2001, Appendix J).

	well	D-8	D-9	D-13	D-17
average chloride concentration (mg/l)	1970s	136	112	280	21
	1980s	160	136	253	70
	1990s	225	152	308	180
% change, 1970s-1980s		+18%	+21%	-10%	+233%
% change, 1980s-1990s		+41%	+12%	+22%	+157%
average production rate (gpm)	1980s	137	168	149	149
	1990s	193	190	163	198
% change, 1980s-1990s		+41%	+13%	+9%	+33%
probable cause of chloride concentrations		pumping rate	pumping rate	local geologic conditions, depth, pumping rate	pumping rate

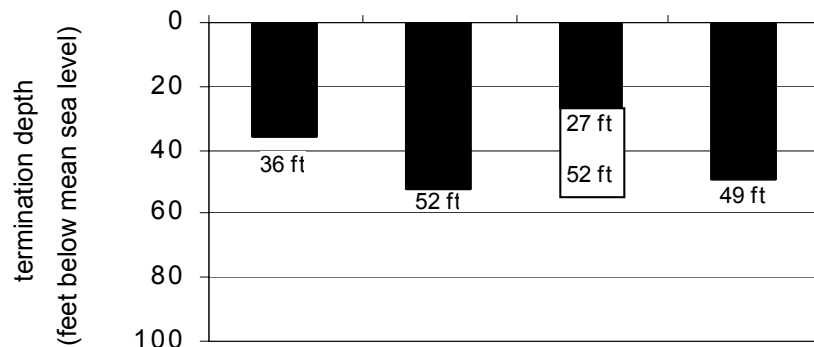

Figure 19. Average chloride concentrations, average monthly production rates, and well termination depths of Yigo Subbasin wells with chloride concentrations over the saltwater upconing benchmark.

Although observation well data did not indicate the occurrence of regional saltwater intrusion, wells close to the coast at which chloride concentrations have risen significantly above the original ranges give some cause for concern. D-17's average chloride concentration increased from 21 mg/l in the 1970s to 180 mg/l in the 1990s. M-6 and M-12's 1970s averages were below 70 mg/l, but increased to exceed this benchmark in the 1980s with average concentrations of 74 and 79 mg/l, respectively. In the 1990s, M-6's average concentration rose 6 mg/l to 80 mg/l while M-12's average concentration rose to 84 mg/l.

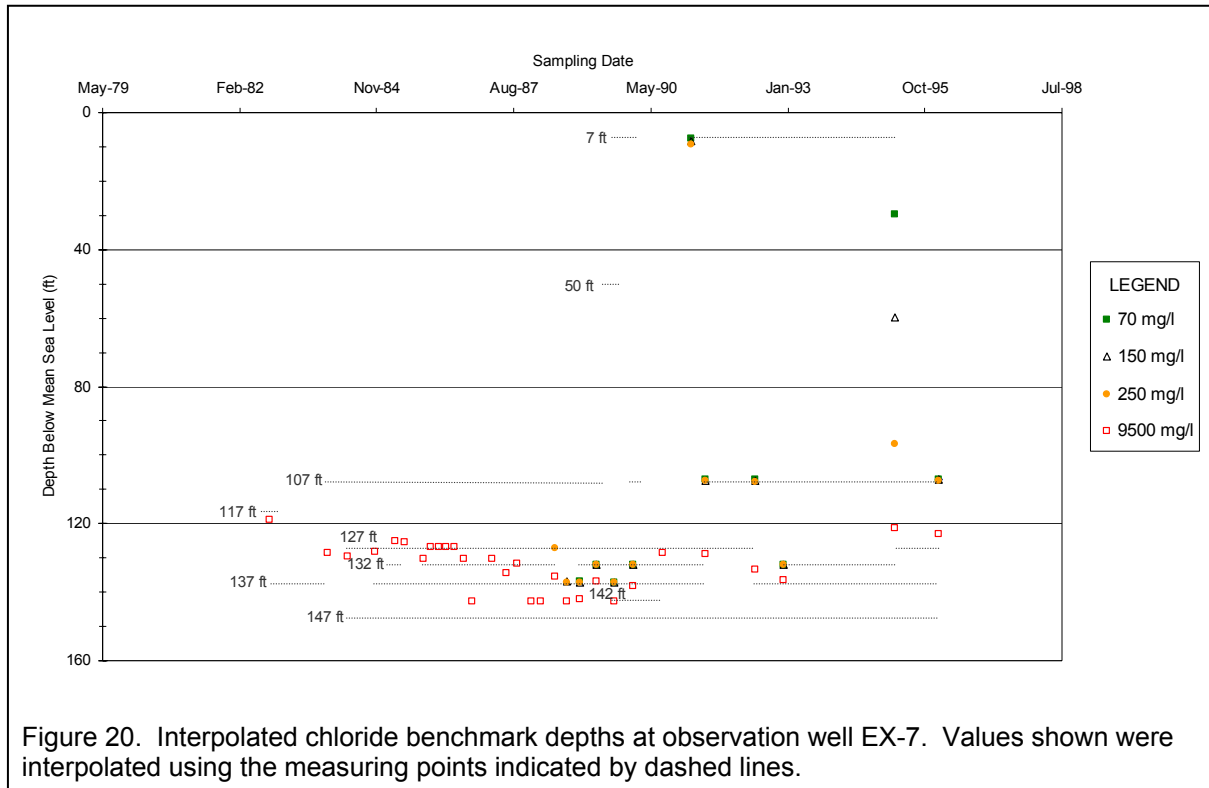

Figure 20. Interpolated chloride benchmark depths at observation well EX-7. Values shown were interpolated using the measuring points indicated by dashed lines.

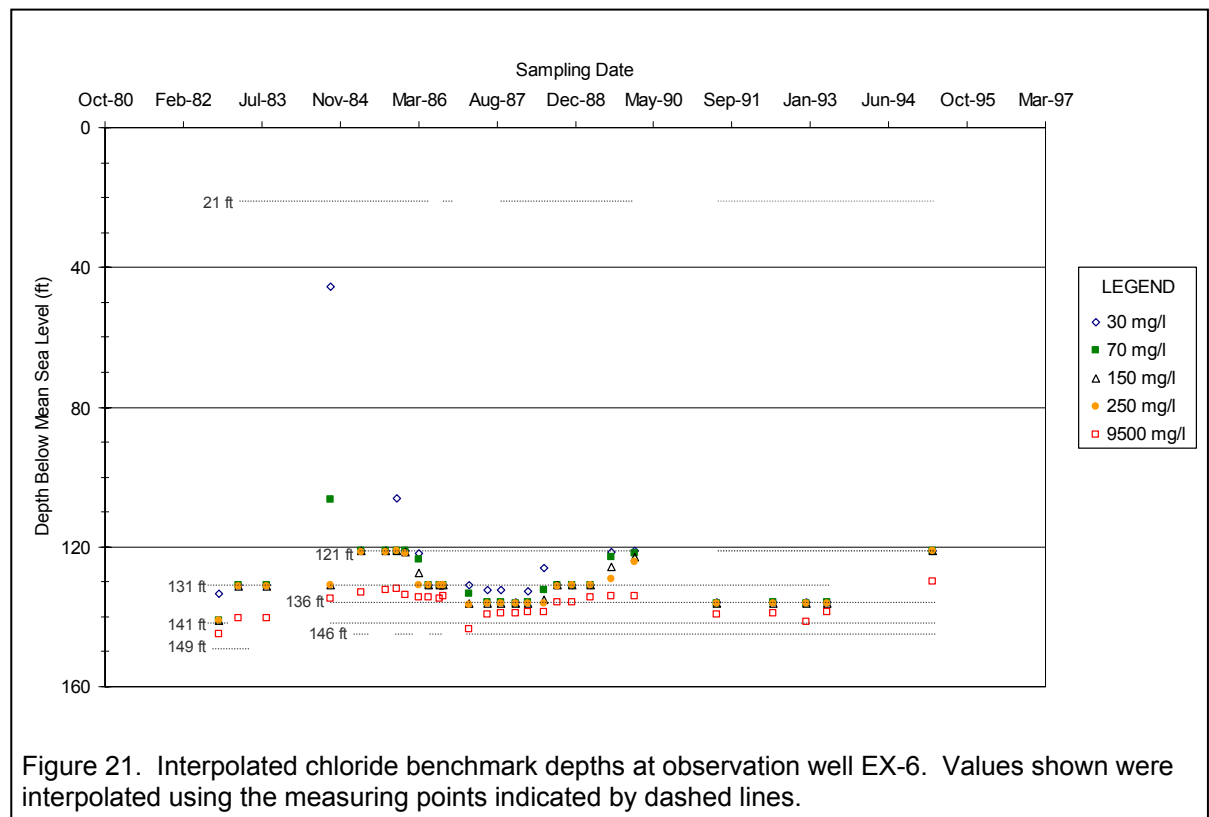
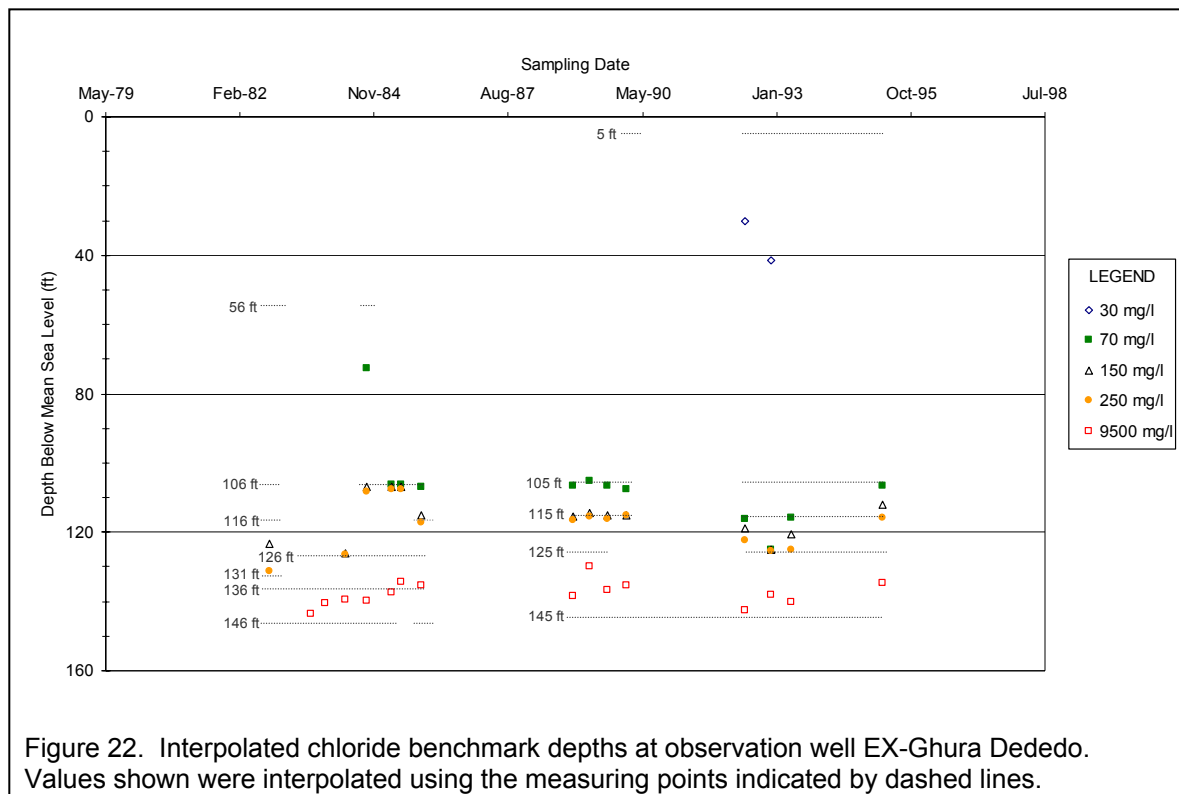

Figure 21. Interpolated chloride benchmark depths at observation well EX-6. Values shown were interpolated using the measuring points indicated by dashed lines.



5.5 Finegayan Subbasin

5.5.1 History of chloride concentrations at production wells

Chloride histories of the Finegayan Subbasin wells are mapped in Figure 23 and shown in Table 9. None of the wells in the subbasin had an average chloride level over the SDW guideline. Chloride averages at Finegayan wells remained below the 150 mg/l upconing benchmark through the 1970s, except for occasional spikes above 150 mg/l at wells F-6 and F-10. However, chloride averages at F-6 and F-10 rose above the upconing benchmark in the 1980s and remained there through the 1990s (see Figure 11). Well F-4's chloride average, which was below 150 mg/l through the 1970s and 1980s, rose above the upconing benchmark in the 1990s. F-13, NCS-A, and NCS-5 were brought on line in the 1990s with starting average chloride levels over 150 mg/l.

5.5.2 Probable causes of chloride concentrations over 150 mg/l

Average chloride ion concentrations, average production rates, and termination depths for wells with chloride concentrations over 150 mg/l are diagrammed in Figure 24. Corresponding data for all other Finegayan wells are listed in the Appendix, taken from McDonald (2001, Appendix I). Chloride in well F-6 increased by 47% (from 123 to 181 mg/l) from the 1970s to 1980s, and by another 12% (from 181 to 203 mg/l) from the 1980s to 1990s. The 12% increase was correlative with a 28% increase in the pumping rate (from 124 to 159 gpm) from the 1980s to the 1990s. At F-4, average chloride rose by 86% (from 80 to 149 mg/l) between the first two decades, and at F-10 by 15% (from 146 to 168 mg/l.) Although pumping rates at F-4 and F-10 decreased from the 1980s to the 1990s (by 4% and 11%, respectively), chloride in both wells rose from the 1980s to 1990s. Between the 1980s and 1990s, average chloride rose an addition 11% in

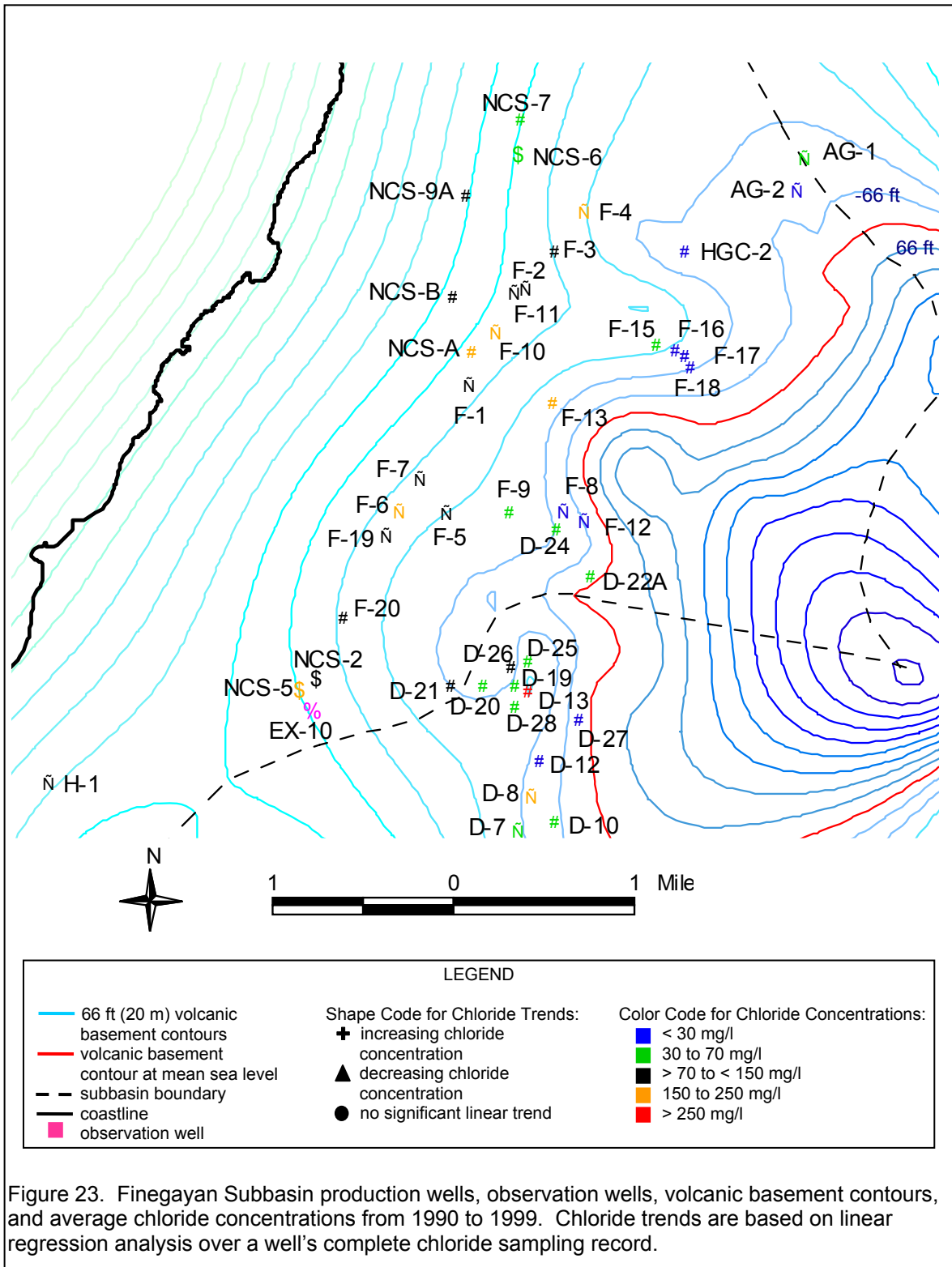

Figure 23. Finegayan Subbasin production wells, observation wells, volcanic basement contours, and average chloride concentrations from 1990 to 1999. Chloride trends are based on linear regression analysis over a well's complete chloride sampling record.

Table 9. Finegayan Subbasin production wells in chloride benchmark categories based on average chloride concentrations in the 1990s.

Original Parabasal Range (<30 mg/l)	Original Saltwater Toe Range (30 to 70 mg/l)	Original Basal Range (>70 to 150 mg/l)	Over Saltwater Upconing Benchmark (150 mg/l to 250 mg/l)	Over SDW Guideline (>250 mg/l)
↑ AG-2	D-22A	D-21	↑ F-4	
↑ F-8	D-24	↑ F-1	↑ F-6	
↑ F-12	F-9	↑ F-2	↑ F-10	
F-16	F-15	F-3	F-13	
F-17	↓ NCS-6	↑ F-5	↓ NCS-5	
F-18	NCS-7	↑ F-7	NCS-A	
HGC-2		↑ F-11		
		↑ F-19		
		F-20		
		↑ H-1		
		↓ NCS-2		
		NCS-9A		
		NCS-B		

↑: Statistically increasing chloride concentrations over the entire period of record

↓: Statistically decreasing chloride concentrations over the entire period of record

No arrow sign indicates that chloride concentrations did not exhibit a significant linear trend over the entire period of record

F-4 (from 149 to 165 mg/l) and 13% in F-10 (from 168 to 190 mg/l). These trends indicate that the pumping rate at each well has been too high since at least the 1980s, and remained excessive, in spite of the modest decreases between the 1980s and 1990s. The termination depths of 35 and 47 ft below msl for F-4 and F-10 may explain the relatively high initial chloride averages for the 1970s (80 and 146 mg/l, respectively) and the subsequent sensitivity of chloride concentration to pumping. F-13 was drilled in the 1990s and though its termination depth was unavailable, the relatively high pumping rate 223 gpm may explain the high chloride. It was pumped at 223 gpm, which is substantially greater than that of neighboring wells with acceptable chloride levels, in which average pumping rates did not exceed 150 gpm in the 1990s. Moreover, the highest pumping rate in the other problem wells (F-4, F-6, F-10, NCS-A, and NCS-5) for the same period was only 159 gpm.

NCS-A has a relatively low production rate and it began operations with fluctuating chloride concentrations (McDonald, 2001, Appendix A). It seems more likely that NCS-A's depth (34 ft below msl) is responsible for its chloride levels especially given its proximity to the coast where the freshwater lens thins and is influenced by tidal fluctuations, making chloride changes more sensitive with depth. NCS-5's average chloride concentration of 219 mg/l is doubtless related to its excessive depth of 79 ft below msl. Chloride profiles at nearby observation well EX-10 (Figure 25) in the 1990s show that water drawn from about 80 ft below msl can have a chloride level as high as 250 mg/l. NCS-5's depth also exceeds the recommended maximum depth of 40 ft below msl for basal wells and 50 ft below msl for parabasal wells (CDM, 1982c).

5.5.3. Saltwater intrusion

Saltwater upconing at F-4, F-6, F-10, F-13, NCS-A, and NCS-5 seem probable, given their proximity to the coast, and the fact that their chloride histories suggest excessive pumping. F-13 lies closest to the parabasal zone inferred from the contour map, but the high chloride from the beginning of operation suggests that the well penetrated to transitional water. Unfortunately, there is no record of the well depth. As noted above, the relatively high pumping rate for this well may also be contributing to

	Decade	F-4	F-6	F-10	F-13	NCS-A	NCS-5
average chloride concentration (mg/l)	1970s	80	123	146	--	--	--
	1980s	149	181	168	--	--	--
	1990s	165	203	190	195	232	219
% change, 1970s-1980s		+86%	+47%	+15%	--	--	--
% change, 1980s-1990s		+11%	+12%	+13%	--	--	--
average production rate (gpm)	1980s	138	124	166	--	--	--
	1990s	132	159	147	223	115	87
% change, 1980s-1990s		-4%	+28%	-11%	--	--	--
probable cause of chloride concentrations		depth and puping rate	pumping rate	depth and pumping rate	pumping rate	depth	depth

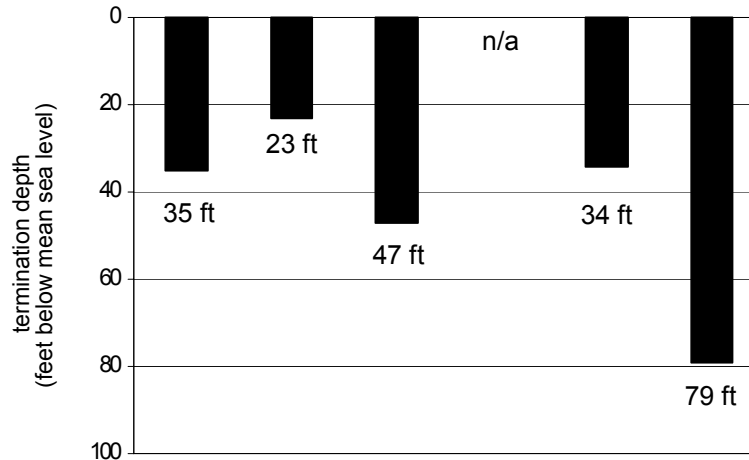

Figure 24. Average chloride concentrations, average monthly production rates, and well termination depths of Finegayan Subbasin wells with chloride concentrations over the saltwater upconing benchmark.

the high chloride. Both explanations—excessive depth, and excessive pumping—however imply a basal rather than parabasal location for the well.

Linear regression of EX-10's 50% isochlor depth over time did not indicate a significant trend (McDonald, 2001, Appendix J). Given that there are no other observation wells in the subbasin, it appears that the high chloride levels in the problem wells are local rather than regional phenomena. Interestingly, the graph of the EX-10's chloride history (Figure 25) shows the same sort of thickening of the upper portion of the lens displayed by EX-7 (Figure 20) in the Yigo Subbasin, at about the same time. In EX-10, the 250 mg/l isochlor appears to have descended from about 50 to 80 ft below msl during 1985, after which it remained stable. Starting at the same time, the 70 mg/l isochlor descended from less than 10 ft below msl, converging to within a few feet of the 250 mg/l isochlor by 1988. The depth both the 70 and 250 mg/l isochlors seems to have stabilized in 1988. Curiously, the average depth of the 50% (9500 mg/l) isochlor seems to have remained constant about 120 ft below msl, while becoming noticeably more

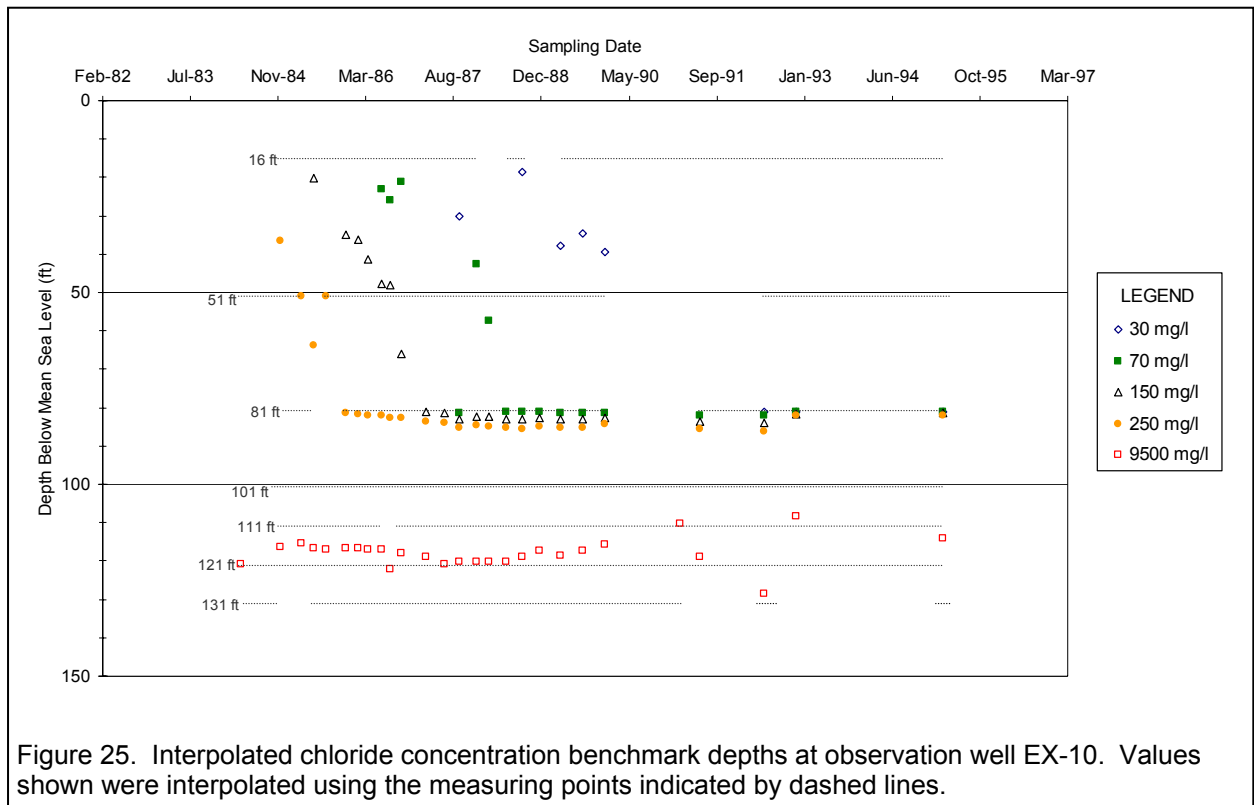

Figure 25. Interpolated chloride concentration benchmark depths at observation well EX-10. Values shown were interpolated using the measuring points indicated by dashed lines.

variable after about 1991, fluctuating since then between 108 and 128 ft below msl. We have been unable to propose an explanation for these extraordinary, apparently simultaneous and similar changes in these two chloride profiles in the two separate subbasins. For this analysis, however, it is sufficient to note that in both cases the deepening of the upper, low chloride portion of the lens would have worked to mitigate rather than exacerbate the effects of groundwater extraction on production well chloride.

Although there is no significant evidence of regional saltwater intrusion in the Finegayan Subbasin, the elevation of chloride at the wells located along the line from F-4 to F-19, parallel to and only about a mile inland from the coast, suggests that the lens is relatively thin along this line, and therefore especially sensitive to pumping rates. By the end of the 1990s, nearly all of the F-series wells parallel to the northwestern coast had significantly increasing chloride concentrations with maximum levels greater than the saltwater upconing benchmark (McDonald, 2001, Appendix H).

5.6 Mangilao Subbasin

5.6.1 History of chloride concentrations at production wells

By the 1990s, the Mangilao Subbasin contained 8 studied wells which are mapped in Figure 26 and listed in Table 10. Average chloride levels, average production rates, and terminations depths for wells with chloride over 150 mg/l are displayed in Figure 27. Corresponding data for the other wells in the Mangilao Subbasin wells are listed in the Appendix, taken from McDonald (2001, Appendix I). Well M-1's average chloride in the 1970s was slightly below the 150 mg/l saltwater upconing benchmark (at 143 mg/l), but rose above it (to 169 mg/l) in the 1980s and continued to rise (to 183 mg/l) into the 1990s, in spite of a 19% decrease (from 157 to 127 gpm) in average pumping rate from the 1980s to the 1990s. Well M-9's average chloride levels were above the benchmark throughout all three decades, rising by

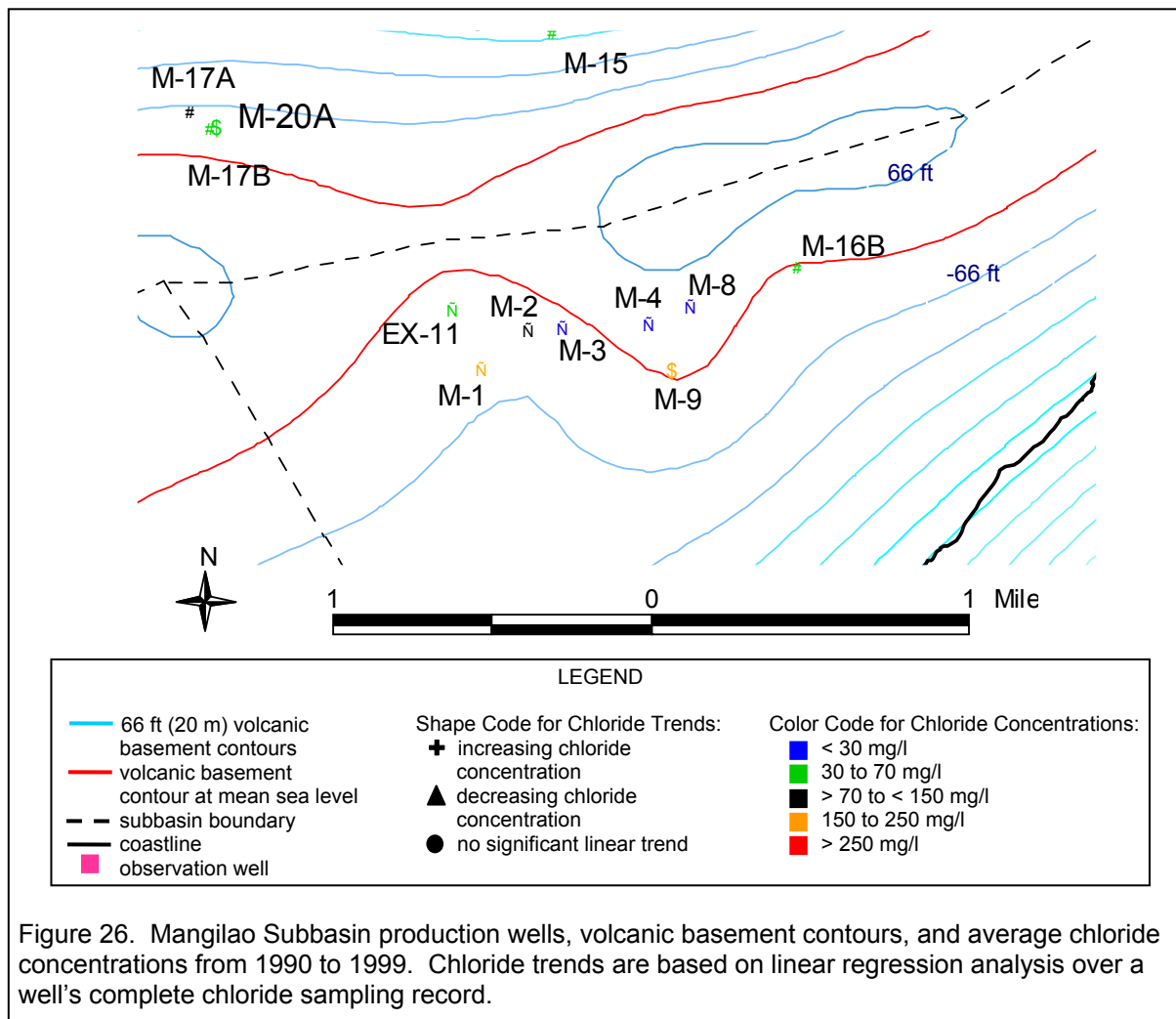

Table 10. Mangilao Subbasin production wells in chloride benchmark categories based on average chloride concentrations in the 1990s.

Parabasal Range (<30 mg/l)	Saltwater Toe Range (30 to 70 mg/l)	Basal Range (>70 to <150 mg/l)	Over Saltwater Upconing Benchmark (150 mg/l to 250 mg/l)	Over SDW Guideline (>250 mg/l)
↑ M-3 ↑ M-4 ↑ M-8	↑ EX-11 M-16B	↑ M-2	↑ M-1 ↓ M-9	

↑: Statistically increasing chloride concentrations over the entire period of record
 ↓: Statistically decreasing chloride concentrations over the entire period of record
 No arrow sign indicates that chloride concentrations did not exhibit a significant linear trend over the entire period of record

	Decade	M-1	M-9
average chloride concentration (mg/l)	1970s	143	196
	1980s	169	232
	1990s	183	163
% change, 1970s-1980s		+18%	+18%
% change, 1980s-1990s		+8%	-30%
average production rate (gpm)	1980s	157	156
	1990s	127	156
% change, 1980s-1990s		-19%	0%
probable cause of chloride concentrations		depth and pumping rate	depth and pumping rate

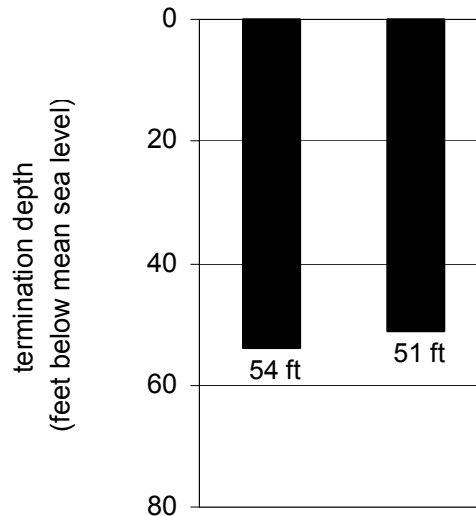

Figure 27. Average chloride concentrations, average monthly production rates, and well termination depths of Mangilao Subbasin wells with chloride concentrations over the saltwater upconing benchmark.

18% (from 196 mg/l to 232 mg/l) between the 1970s and 1980s, then dropping by 30% (to 163 mg/l) between the 1980s and 1990s. However, average production between the 1980s and 1990s remained constant.

5.6.2 Probable causes of chloride concentrations over 150 mg/l

Both of these problem wells terminate more than 50 ft below msl. Both are also close to the coast. Their locations suggest that they were sited with the intent to intercept parabasal water. However, because the basement slope is steep and the wells are close to the coast in this subbasin, the parabasal zone is generally narrow and the location of the saltwater toe may be variable. Termination depth is certain to be a factor in explaining the relatively high chloride in these two wells. They also lie farther seaward than the other wells in the subbasin, and although the difference in distance to the coast between

these and the other wells is fairly small, the steepness of the basement and the general proximity to the coast likely make the lens thickness sensitive to distance inland, and probably somewhat more variable as well. The fact that chloride continued to rise in M-1 in spite of reduction in pumping rate suggests that the rate had been, and still remains, too high. Given the depth of the well, the initial chloride concentration of the 143 mg/l is probably the best quality that can be obtained from this well. Well M-9's history is curious, in that it showed a substantial (30%) drop in chloride between the 1980s and 1990s, in spite of no change in the production rate. Mink (1976; 1991) attributed M-9's high chloride to its termination depth and the possibility that local vertical conductivity may be higher than horizontal conductivity. The high chloride during the first decade of operation suggests that the well is certainly set to deep. The drop in chloride in spite of the constant pumping rate suggests that the lens profile is sensitive to changes in local recharge conditions. We offer no specific explanation for this apparent anomaly at this time, but the apparently spontaneous variability may be characteristic of this well. Given the depth of the well, however, and its previous history, it seems unlikely that water quality at this well will continue to improve or even remain at the 1990s average at the current pumping rate. At the given pumping rate, chloride will more likely fluctuate near the range of the historical values.

5.6.3 *Saltwater intrusion*

No chloride profile data are available from observations wells for this subbasin. The close proximity of the watershed divide to the coast, and the steep gradient of the basement contact combine to make the location of the parabasal zone and thickness of the basal zone difficult to predict, over both space and time. Because local conditions are so variable, local rather than regional conditions are more likely to constrain siting, design, and management decisions for wells in this subbasin.

6.0 CONCLUSIONS AND RECOMMENDATIONS

The recommendations given below are based on four criteria. First, chloride in water delivered at the tap should not exceed the 250 mg/l USEPA Secondary Standard. This implies that water produced at the wellhead should generally meet this standard as well, if the area is capable of producing water of this quality or higher. Although tap water chloride concentration can be kept to standard by diluting water from high-chloride wells with water from low-chloride wells, such practice can only succeed over the long term if sufficient low-chloride production is maintained such that the high-chloride production can be sufficiently diluted. Therefore, wells exceeding the 250 mg/l guideline ultimately threaten water quality at the tap and should therefore be marked for remediation or closure. In wells where excessive chloride is the result of too high a pumping rate rather than excessive depth, the pumping rate should be decreased until the chloride stabilizes at least below 250 mg/l, preferably below 150 mg/l. If the chloride cannot be eventually brought below 250 mg/l, the well should be closed. Wells that have been drilled too deep for production to be restored to at least below 250 mg/l at economical pumping rates should be closed. Experience has amply demonstrated that so-called "back-filling" of excessively deep holes does not restore water quality. The consistent failure of this approach makes it clear that filled boreholes retain a highly conductive hydraulic pathway between the pump and the lower section of the borehole that is in contact with high-chloride water. Therefore, back-filling of boreholes should no longer be considered as an option for remediation.

Chloride concentrations from 150 to 250 mg/l constitute a "gray zone." Although the water is within standard, the quality is lower than what the aquifer is judged generally capable of producing with proper well design and management (CDM, 1982b). The second recommended management criterion is therefore that chloride concentration exceeding 150 mg/l should be regarded as diagnostic of saltwater intrusion resulting from improper design or mismanagement, so that wells exhibiting chloride between 150 and 250 mg/l should be tagged as "problem wells" and marked for remediation. For wells that have not been drilled too deep to achieve chloride levels below 150 mg/l at lower pumping rates, it may be possible to rehabilitate them simply by reducing the pumping rate to a level at which chloride concentration stabilizes at or below 150 mg/l. Management may choose to maintain wells that cannot be brought below 150 mg/l by reducing the pumping rate, if the long-term net cost of replacing the production from the well with production from higher-quality wells exceeds the costs associated with keeping the lower-quality well in production. Evaluation of the economic factors determining the optimum mix of production rates, water quality, considering the costs of maintaining production from existing wells and developing additional or replacement production from new wells is beyond the scope of this study. Until such a study can be made the basis for more precise management, managers should attempt to remediate wells producing water with more than 150 mg/l. This is probably best done by systematically lowering the pumping rates at such wells while bringing higher quality wells on line to compensate for reduced production at the remediated wells and to meet growing demand.

Third, wells in which chloride is currently below 150 mg/l, but is consistently rising, and especially where it is approaching the 150 mg/l benchmark, should be marked as "suspect." For such wells, individual management plans should be written to identify appropriate steps for remediation, based on current performance and past chloride history. Management plans should determine the level of chloride that is acceptable for the long term, estimate the pumping rate needed to achieve it, and suggest an appropriate plan for reduction of the pumping rate and replacement of the lost production.

Finally, wells that are producing high quality water and show no statistically significant increase in chloride obviously need no remedial steps, but may be examined for possible production increase as a means of offsetting lost volume from the remediation or closure of other wells. Such examination must be done as part of a broader engineering study of how transmission and storage might also be redirected to move water from areas that could produce surplus water to areas where the water is needed. Determining which wells might be operating "under capacity" however, was outside the scope of this study, which focused rather on identifying which wells exhibited evidence of evidence or trends toward contamination, and what the cause in each case might be. Such a study is recommended, however, as a

next step toward optimizing the production of the aquifer. In the meantime, regular (at least quarterly) sampling should continue at these wells, along with all the others.

In summary, there are in general four courses of action for managing chloride in the water production system in the immediate future, based on the observations reported in this study:

1. Continued quarterly sampling at all production wells, including those with acceptable chloride histories
2. Timely preventive action for wells showing evidence for possible deterioration to arrest or reverse deterioration in water quality
3. Remediation of wells for which chloride persistently exceeds 150 mg/l, but for which this study suggest quality might be improved by reducing the pumping rate, and
4. Closure and replacement of wells with chloride exceeding 150 mg/l for which the observations of this study suggest that reducing the pumping rate is unlikely to improve water quality.

On the basis of the observations reported in this study, we therefore classify the chloride performance of each well, in each subbasin, as (1) acceptable, (2) acceptable but showing suspect trends or other behavior that suggests quality may be deteriorating, (3) unacceptable but remediable, and (4) unacceptable and irreparable. We recommend the following actions for each category.

6.0.1 *Wells of acceptable quality*

Quarterly wellhead sample collection should continue at every production well, and the chloride trend should be tracked for each well, regardless of its history to date. Data collected on wells that show stable chloride well below 150 mg/l will provide a basis for evaluating which of such wells might be able to produce additional water of acceptable quality.

6.0.2 *Suspect wells*

A management plan should be prepared to identify appropriate preventive steps for each well that is currently producing water below the 150 mg/l benchmark but has exhibited a statistically significant increasing chloride trend or, if no trend was determined, had concentrations consistently near the 150 mg/l benchmark. Priorities for action (based on the rate of chloride increase or closeness to the benchmark) should be established within each subbasin for taking preventive measures at suspect wells. Wells in which chloride is rising at the greatest rate, or closest to the 150 mg/l benchmark should be given the highest priority.

There are three alternatives for preventive management of wells with deteriorating water quality, or for remediation of wells with unacceptable water quality. The first and most drastic alternative is to shut the well down temporarily and allow the lens to recover before bringing the well back into service. This approach is advised for wells with chloride that is rapidly rising, approaching, or already exceeding the 150 mg/l benchmark, and which can be taken out of production without imposing unacceptable reduction in the ability to meet current demand. Where the system has sufficient reserve capacity or an alternate source can be brought into production promptly, this approach will likely result in the most reliable and rapid rehabilitation of the well. R. Carruth has reported (personal communication, 4/3/2003) from his experience on Saipan that “recovery from localized saltwater intrusion can be relatively rapid (on the order of a few months to a few years) in the high permeability limestone aquifers in the Mariana Islands, such as the coastal aquifers found on Saipan and Guam”.

Once the lens has recovered, the well can be brought back into production at some conservative fraction (e.g., 30-50%) of its original pumping rate. If subsequent monitoring shows that the chloride has stabilized at an acceptably low level, production can be incrementally increased to a higher, but sustainable, rate that maintains chloride below 150 mg/l. A second alternative is to continue pumping, but at a substantially reduced rate (i.e., 50-70%), with subsequent monitoring and, if water quality is sufficiently good, deliberate incremental increases to eventually achieve the highest sustainable production rate at an acceptable level of quality. The third alternative is to keep the well on line at the current rate but incrementally reduce the current pumping rate until a chloride concentration stabilizes at a

sustainable level. This approach may be the slowest to achieve results but may be the most practical where demand is high, reserve is insufficient, and reduction in production is not practicable until alternative production is brought into service to meet demand.

6.0.3 Remediable wells

The same alternatives described in the section above apply for remediation of wells that already exceed the 150 mg/l benchmark. There are two differences in application, however. First, where chloride already exceeds 150 mg/l there is no question that remedial steps are appropriate. Second, the more drastic options, *i.e.*, complete shutdown, or summary reduction followed by stepped increases, may be more appropriate, depending on how severely the current chloride contamination from the well is affecting the quality of water delivered to consumers.

6.0.4 Irremediable wells

Wells with unacceptably high chloride (*i.e.*, >150 mg/l), but which cannot be remediated (for example, those that terminate at excessive depth) should be closed. Highest priority for closure should be given to the wells that exhibit the highest chloride in each subbasin.

6.1 Agana Subbasin

The Agana Subbasin has the most high chloride wells and the highest chloride concentrations of all of the aquifer subbasins. Recommendations for Agana Subbasin wells are listed in Table 11. Wells A-3, A-8, A-11, A-12, and A-32 maintained chloride ion concentrations in the parabasal range, while NCS-8 maintained concentrations in the basal range. These wells are performing acceptably, though quarterly chloride sampling should be continued to monitor well performance.

Six wells maintained chloride ion levels in a given freshwater range, although chloride levels were statistically increasing. Wells A-1, A-2, A-5, A-7, and NRMC-1 had chloride ion concentrations that were in the parabasal range but were statistically increasing. These wells should be flagged as “at risk” wells and remedial action taken if chloride concentrations rise out of expected freshwater ranges.

Twelve Agana Subbasin wells require remedial action, as listed in Table 11. Chloride averages at wells A-4, A-6, A-23, A-25, and A-31 were below 30 mg/l, but data points rose over this benchmark into the saltwater toe range. A-29 and NRMC-3 had chloride concentrations that fluctuated between the parabasal and basal ranges. NRMC-2’s levels fluctuated from parabasal concentrations to over the saltwater intrusion benchmark. A-26 had chloride concentrations that fluctuated between saltwater toe and basal ranges. Chloride levels at NCS-3 started in the basal range, but then exceeded it. A-15’s concentrations were also rising, although levels up to December 1999 were in the basal range. A-30 levels ranged from parabasal concentrations to over 250 mg/l.

For decades, nine wells have exhibited chloride ion levels that indicate saltwater upconing. A-9 and A-28’s chloride ion levels regularly exceeded 150 mg/l since the start of their chloride records. Seven wells, A-10, A-13, A-14, A-17, A-18, A-19, and A-21, exceeded the SDW guideline for decades. These seven wells have been in operation for at least the recommended 25-year design life for water production wells (Driscoll, 1986). In addition, chloride profiles from observation well EX-1 indicate that the wells were drilled to deep to avoid natural chloride fluctuations in the lens. These wells should therefore be shut down. Chloride profiling of at least one well, preferably A-13, should be conducted semi-annually to monitor lens recovery. In time, new wells may be drilled in the area. However, these new wells should be shallow. Although the NGLS (CDM, 1982c) recommends a maximum depth of 40 ft for basal wells, these new wells should terminate no deeper than 20 ft below msl and should have a production rate no greater than 150 mg/l, but preferably lower.

6.2 Yigo Subbasin

More groundwater is extracted from the Yigo Subbasin than any other. While most of the wells have acceptable chloride ion concentrations, D-8, D-9, D-13, and D-17’s chloride levels suggest saltwater upconing, based on CDM’s (1982b) 150 mg/l indicator benchmark. Table 12 lists wells and suggested management practices.

Table 11. Recommendations for Agana Subbasin wells.

Water Quality Benchmark	Monitor Only	Management Plan	Remediate	Close
Parabasal Quality <30 mg/l	A-3 A-8 A-11 A-12 A-32	A-1 A-2 A-5 A-7 NRMC-1	A-6	
Saltwater toe Quality 30 to 70 mg/l			A-4 A-23 A-25 A-29 A-30 A-31 NRMC-2 NRMC-3	
Basal Quality >70 to <150 mg/l	NCS-8		A-26 NCS-3	
Exceeds Upconing Benchmark ≥ 150 mg/l			A-15	A-9 A-28
Exceeds USEPA Guideline > 250 mg/l				A-10 A-13 A-14 A-17 A-18 A-19 A-21

Nineteen wells maintained chloride levels in a groundwater range: D-27, Y-6, Y-7, Y-18, Y-19, and Y-20 had chloride concentrations in the parabasal range while D-3, D-4, D-5, D-10, D-20, D-28, M-17B, M-18, M-20A, M-21, Y-10, Y-12, and Y-14 maintained levels in the saltwater toe range.

Twenty-one wells also maintained a groundwater chloride range, though levels were statistically increasing or occasionally exceeded that range. Chloride concentrations at D-12, D-25, Y-1, Y-2, Y-3, Y-4A, and Y-9 were primarily in the parabasal range. Y-4 also had levels mostly in the parabasal range, though the well was shut down and replaced with Y-4A. D-1, D-2, D-6, D-7, D-19, EX-5A, M-5, M-7, M-15, and Y-5 had concentrations primarily in the saltwater toe range. Chloride levels at D-15, D-16, and GH-501 were predominantly in the basal range.

As listed in Table 12, 11 wells require remediation. D-14, D-18, M-6, and M-12's levels ranged from saltwater toe values to basal values. M-14 and M-17A had chloride levels ranging from parabasal to basal concentrations. D-9 had concentrations that began in the basal range then exceeded 150 mg/l in the 1990s. D-11 and D-26 occasionally exceeded 150 mg/l. D-8's chloride levels were primarily in the basal

range but had spikes over 250 mg/l. D-17 had chloride levels range from parabasal concentrations to over 250 mg/l.

D-13 has exceeded the SDW guideline for decades, due to a combination of increasing pumping rates, depth, and also possibly due to local vertical permeability being greater than horizontal permeability (Mink, 1976). D-13 should therefore be shut down or converted to an observation well.

Table 12. Recommendations for Yigo Subbasin wells.

Water Quality Benchmark	Monitor Only	Management Plan	Remediate	Close
Parabasal Quality <30 mg/l	D-27 Y-6 Y-7 Y-18 Y-19 Y-20	D-12 D-25 Y-1 Y-2 Y-3 Y-4 Y-4A Y-9		
Saltwater toe Quality 30 to 70 mg/l	D-3 D-4 D-5 D-10 D-20 D-28 M-17B M-18 M-20A M-21 Y-10 Y-12 Y-14	D-1 D-2 D-6 D-7 D-19 EX-5A M-5 M-7 M-15 Y-5		
Basal Quality >70 to <150 mg/l		D-15 D-16 GH-501	D-14 D-18 M-6 M-12 M-14 M-17A	
Exceeds Upconing Benchmark ≥ 150 mg/l			D-9 D-11 D-26	
Exceeds USEPA Guideline > 250 mg/l			D-8 D-17	D-13

6.3 Finegayan Subbasin

The Finegayan Subbasin's 32 wells are listed in Table 13 with suggested management practices. Eleven wells were operating satisfactorily. F-16, F-17, F-18, and HGC-2 maintained chloride concentrations in the parabasal range. D-24, NCS-6 and NCS-7's levels were in the saltwater toe range. Chloride levels at F-3, NCS-2, NCS-9A, and NCS-B were in the basal range.

Table 13. Recommendations for Finegayan Subbasin wells.

Water Quality Benchmark	Monitor Only	Management Plan	Remediate	Close
Parabasal Quality <30 mg/l	F-16 F-17 F-18 HGC-2	AG-2 D-22A F-8 F-12		
Saltwater toe Quality 30 to 70 mg/l	D-24 NCS-6 NCS-7	D-21 F-15		
Basal Quality >70 to <150 mg/l	F-3 NCS-2 NCS-9A NCS-B	F-1 F-2 F-11 F-19 F-20	F-5 F-7 F-9	
Exceeds Upconing Benchmark ≥150 mg/l			F-4 F-6 F-10 H-1	NCS-5
Exceeds USEPA Guideline >250 mg/l			F-13 NCS-A	

The wells in a line from F-19 to F-4 have statistically increasing chloride levels (see Figure 23). Eleven wells are flagged for management plans. AG-2, D-22A, F-8, and F-12 levels were mainly in the parabasal range (D-22A was shut down in the 1990s). D-21 and F-15 had chloride concentrations in the saltwater toe range. Chloride levels at F-1, F-2, F-11, F-19, and F-20 were predominantly in the basal range.

Remediation is required for nine wells. F-5, F-7, and F-9 had chloride ion levels that ranged between the saltwater toe and basal ranges. F-4, F-6, F-10, and H-1's levels also exceeded 150 mg/l, suggesting saltwater upconing. F-13 and NCS-A's concentrations occasionally exceeded the Safe Drinking Water guideline, also suggesting saltwater upconing.

NCS-5's history of having chloride ion levels exceed 150 mg/l is most likely due to its extreme depth. NCS-5 should therefore be shut down. Because there is already an observation well (EX-10) in close proximity to NCS-5, converting NCS-5 to an observation well should not be a priority.

6.4 Mangilao Subbasin

The majority of the Mangilao Subbasin wells have statistically increasing chloride levels. Management suggestions for the subbasin's eight production wells are listed in Table 14. Six wells have been flagged as potential candidates for management plans. M-3, M-4, and M-8's concentrations are also statistically rising, but concentrations have been in the parabasal range. EX-11 has maintained chloride ion concentrations in the saltwater toe range, though a positive trend has been proven. M-16B had chloride levels fluctuating between parabasal to saltwater toe ranges, but was shut down in the 1990s. M-2's chloride levels are increasing, though concentrations were in the basal range.

Table 14. Recommendations for Mangilao Subbasin wells.

Water Quality Benchmark	Monitor Only	Management Plan	Remediate	Close
Parabasal Quality <30 mg/l		M-3 M-4 M-8		
Saltwater toe Quality 30 to 70 mg/l		EX-11 M-16B		
Basal Quality >70 to <150 mg/l		M-2		
Exceeds Upconing Benchmark ≥150 mg/l			M-9	M-1
Exceeds USEPA Guideline >250 mg/l				

M-9 has exceeded the saltwater upconing benchmark since the 1970s. However, it has a statistically decreasing trend and should be remediated to bring the chloride concentrations below 150 mg/l. M-1 had chloride levels over 150 mg/l since the 1980s and should therefore be shut down. The conversion of M-1 to an observation well would provide chloride profiles that would aid in subbasin management.

6.5 Agafa Gumas and Andersen Subbasins

The two production wells in the Agafa Gumas and Andersen Subbasins both produce water with relatively low chloride ion levels. However, while Y-15 has maintained levels in the parabasal range with no indication of rising, AG-1's concentrations have fluctuated between the parabasal and saltwater toe chloride ranges. AG-1 therefore requires remediation.

Table 15. Recommendations for Agafa Gumas and Andersen Subbasin wells.

Water Quality Benchmark	Monitor Only	Management Plan	Remediate	Close
Parabasal Quality <30 mg/l	Y-15			
Saltwater toe Quality 30 to 70 mg/l			AG-1	
Basal Quality >70 to <150 mg/l				
Exceeds Upconing Benchmark ≥150 mg/l				
Exceeds USEPA Guideline >250 mg/l				

6.6 New production wells

Lowering pumping rates or shutting off existing wells would result in a deficit in groundwater production. Although as previously mentioned, additional study of wells with acceptable chloride concentrations might indicate that some could sustain higher production rates, expansion of aquifer production in the meantime should be limited to the installation of new wells, which should be properly located, built, and managed to produce high quality water.

Agafa Gumas and Andersen Subbasins are currently underutilized, and could probably support significant production, especially from shallow, low-capacity wells. In other areas, where the most accessible sites are already exploited, the approach to well construction in the NGLA will require a change from selecting sites for convenience (*e.g.*, locations on government property or proximity to existing roads and power lines).

Pumping rates should be identified with regard for initial chloride concentration and well depth. As previously cited, the NGLS recommended that wells terminate at 25 ft below msl in basal areas with freshwater heads less than 4 ft above msl, at 35 ft below msl in basal areas with freshwater heads greater than 4 ft above msl, and at 50 ft below msl in parabasal zones (CDM, 1982c). The NGLS also

recommended maximum pumping rates of 200 gpm in basal areas with heads less than 4 ft above msl, 350 gpm in basal zones with heads greater than 4 ft above msl, and 200 to 750 gpm in parabasinal areas (CDM, 1982c). These guidelines continue to be valid and should be rigorously followed. Shallow wells, of course, have a shorter well screen and therefore a smaller production capacity than deeper wells. More modest pumping rates (e.g., 150 gpm, or even at 100 gpm) will minimize upconing and provide for maximum reliability of well fields over time. Available local hydraulic conductivity values from existing wells (McDonald, 2001, Appendix E) can be used to choose an appropriate production rate.

6.7 Data collection at observation wells

Under the current USGS/WERI-sponsored program of data collection, chloride concentration profiles are measured quarterly in at least one observation well that penetrates to the 100% seawater depth in each subbasin. However, because measurement focuses on identifying the depth of the 50% isochlor, the accuracy of the profile in the near-surface zone (from which water is extracted by production wells) down to the 50% isochlor depth is limited. Moreover, because the sampling frequency is no more than quarterly, the degree of temporal variability is not well constrained either. The data to date, as shown in Figures 14, 16, 17, 20, 21, 22, and 25, however, suggest that there may be considerable variability over both space and time, and such variability suggests that chloride distribution in the aquifer may be controlled not only by spatial variations in hydrogeologic conditions, but may also be influenced by dynamic process such as stage-dependent water routing through alternative pathways.

More accurate understanding of the variability of chloride over time and depth in the fresh-water lens in the different aquifer sub-basins is a crucial next step toward to more accurate understanding of the conditions and processes that control the chloride concentrations in the zone from which production wells extract water. Optimum management in the future, especially as current sustainable limits are reached, will require better understanding of the natural processes that control the chloride concentration around wells and the sensitivity of their responses to pumping. Sampling for chloride profiles in the USGS observation wells should therefore include more frequent sampling and finer spatial resolution (*i.e.*, at 10 to 20 foot intervals) of the chloride concentration from the surface to the 100% seawater depths. Selected wells should be instrumented to measure chloride concentration at frequent (15 to 30 minute) regular intervals until the temporal scale of variability can be resolved, particularly the rate and magnitude of response to intense short term recharge events such as tropical storms or thunderstorms. Once the actual scale of temporal and spatial variability is resolved, sufficiently frequent and spatially resolved sampling should continue to track seasonal and other longer-term variations that might be found to exist in the lens. Such data will provide a basis for more accurate and precise evaluation of the severity and causes of suspected trends in chloride concentration, and therefore more reliable recommendations for effective preventive and remedial management actions.

6.8 Modeling study of aquifer response to pumping

The correlations between chloride concentrations and pumping rates observed at wells A-9, A-10, A-13, A-14, A-17, A-18, A-19, A-21, A-28, D-8, D-9, D-13, D-17, F-6, F-13, M-1, and M-9 in this study provide important insights into the local response of the freshwater lens response to overpumping. This study has also made an important first step toward quantifying the regional response to total pumping by identifying the incidence and magnitude of long-term trends in chloride at all of the production wells, including those in which chloride concentration still remains acceptable. A notable result of the trend analysis is that of the 105 extant wells that were not identified as over-pumped (see Table 5), 49 wells (47%) showed positive trends in chloride. Equally notable, however, is that 52 wells (50%) did not exhibit statistically significant trends in chloride concentration, while 4 wells actually exhibited decreasing trends. At this point, we have no basis for discerning how much of the increase in the chloride at wells showing positive trends is a regional response to the total pumping effort in the respective sub-basin, or whether the observed increases reflect mostly local responses to pumping at the individual wells.

The data from the observation wells examined in this study did not show statistically significant trends in the 50% isochlor depth over the study period. This suggests, on one hand, that positive trends

are local effects of pumping at individual wells. On the other hand, the ubiquity of the positive trends suggests that that some regional upward trend is present on the upper depths, from which water is extracted, but is not being reflected by the location of the 50% isochlor depth in the observation wells. As noted in the section above, the observation well data suggest that the chloride concentrations in the upper portion of the lens varies over both time and place, although the degree of variability are yet to be definitively resolved. These suggest that natural processes, such as temporal spatial distribution of storm water, or the activation of stage-dependent alternate flow paths within the vadose or phreatic zones may have important effects on the chloride concentrations in the upper portion of the lens. Because of these complications, it seems premature to attempt to interpret spatial patterns or hydrogeological explanations for the distribution of wells showing trends (positive or negative) or those not exhibiting trends.

To support a reliable interpretation of the magnitudes, trends, and spatial distribution of the trends observed in this study, some basis is needed for predicting sub-basin responses of the vertical chloride distribution (especially in the upper zone from which water is pumped) to short- and long-term changes in recharge, as well as to the long-term effect of pumping. In addition to field data that could be obtained from observations wells configured with the kind of instrumentation described above, simulated responses from numerical models would help to bound the magnitudes and rates of response that might be expected from changes in recharge and pumping. Two-dimensional cross section and three-dimensional simulations would be of particular value for identifying theoretical limits to the magnitudes and rates of change in chloride profiles that might be induced by a given change in the water budget. Moreover, simulations would provide a means for controlling for one effect while investigating another. The effect of pumping, for example, could be isolated from the effects of short-term, seasonal, and long-term changes in recharge, and vice versa. This is an important advantage of modeling, because field data inevitably reflect the effects of multiple processes. We therefore propose numerical modeling studies of the most important aquifer sub-basins (Yigo, Finegayen, and Agana) to identify, on the basis of the current understanding of aquifer properties from recent previous modeling studies (Jocson et al, 2002, Contractor and Jenson, 2001) the theoretical sensitivity of the lens to changes in recharge and pumping. Such studies will provide a valuable tool for interpreting field data from instrumentation of the kind describe above, and ultimately for reliably interpreting the causes of the trends observed in the production wells that were documented in this study.

REFERENCES

- Barnett, V. and Lewis, T., 1984. *Outliers in Statistical Data*. John Wiley & Sons, Great Britain.
- BCG, 1992. *Groundwater in Northern Guam: Sustainable Yield and Groundwater Development Final Engineering Report*, Barrett Consulting Group in association with John F. Mink for Public Utility Agency of Guam.
- CDM, 1982a. *Northern Guam Lens Study, Groundwater Management Program, Appendix C: Well Construction Manual*, Camp, Dresser and McKee, Inc. in assoc. with Barrett, Harris & Associates *for* Guam Environmental Protection Agency.
- CDM, 1982b. *Northern Guam Lens Study, Groundwater Management Program, Aquifer Yield Report*, Camp, Dresser and McKee, Inc. in assoc. with Barrett, Harris & Associates *for* Guam Environmental Protection Agency.
- CDM, 1982c. *Northern Guam Lens Study, Groundwater Management Program, Summary Report*, Camp, Dresser and McKee, Inc. in assoc. with Barrett, Harris & Associates *for* Guam Environmental Protection Agency.
- Chandler, R.L. and McWhorter, D.B., 1975. Upconing of the salt-water - fresh-water interface beneath a pumping well. *Ground Water*, 13: 354-359.
- Clayshulte, R.N., 1985. *Historical water quality of PUAG production water wells*. Technical Report 57, Water & Energy Research Institute of the Western Pacific, University of Guam, Mangilao.
- Clesceri, L., Greenberg, A. and Trussell, R., (Eds.), 1989. *Standard Methods for the Examination of Water and Wastewater*. Port City Press, Maryland.
- Driscoll, F.G., 1986. *Groundwater and Wells*. Johnson Filtration, Minnesota.
- Falkland, A. (Editor), 1991. *Hydrology and water resources of small islands: A practical guide*. UNESCO, Paris, 317 pp.
- FAO, 1997. *Seawater intrusion in coastal aquifers: guidelines for study, monitoring, and control*., Food and Agriculture Organization of the United Nations, Rome, Italy.
- Linsley, R.K., Kohler, M.A. and Paulhus, J.L.H., 1986. *Hydrology for Engineers*. McGraw-Hill, Inc., 508 pp.
- McDonald, M.Q., 2001. *Analysis of Saltwater Intrusion in the Northern Guam Lens Aquifer based on chloride ion concentrations at production and observation wells*. M.S. Thesis, University of Guam, 80 pp.
- Mink, J.F., 1976. *Groundwater resources on Guam: Occurrence and Development*. Technical Report No. 1, Water and Energy Research Institute of the Western Pacific, University of Guam, Mangilao.
- Mink, J.F., 1991. *Groundwater in Northern Guam: Sustainable yield and groundwater development*, Barrett Consulting Group for Public Utility Agency of Guam.
- Natarajan, O. V., 6/3/1975. *Inter-Agency Memorandum to Chief Officer, Public Utility Agency of Guam from Administrator, Guam Environmental Protection Agency*.
- Stearns, H.T., 1937. *Geology and Water Resources of the Island of Guam, Mariana Islands*. US Navy Manuscript.
- Todd, D.K., 1960. *Salt water intrusion of coastal aquifers in the United States*, International Association of Scientific Hydrology, General Assembly of Helsinki, pp. 452-461.
- Todd, D.K., 1980. *Groundwater Hydrology*. John Wiley & Sons, New York.
- USEPA, 2001. *National Primary Drinking Water Regulations*. United States Environmental Protection Agency.

- Vann, D.T., 2000. Unpublished project: revision of Northern Guam Lens basement volcanic contours, Water & Environmental Research Institute, University of Guam.
- Ward, P.E., Hoffard, S.H. and Davis, D.A., 1965. Hydrology of Guam, U.S. Geological Survey Professional Paper 403-H, US Government Printing Office, Washington, D.C.
- Zarr, J.H., 1984. Biostatistical Analysis. Prentice Hall, Inc., New Jersey.

APPENDIX

**AVERAGE CHLORIDE ION CONCENTRATIONS, RATE OF CHLORIDE
CHANGE OVER TIME, WELL TERMINATION DEPTHS, AND
BOREHOLE ANOMALIES FOR PRODUCTION WELLS
(FROM MCDONALD, 2001, APPENDIX I)**

Average Chloride Ion Concentrations, Rate of Chloride Ion Change Over Time, Well Termination Depths, and Borehole Anomalies for Agana Subbasin Wells.

*the rate of chloride change over time is the linear regression equation slope based on the well's entire chloride concentration record

-- indicates that the regression equation did not significantly represent the data at an α level of 0.05

blank entries indicate that data were unavailable or the well was not operating

Well	Chloride Ion Concentrations				Production Rate		Termination Depth (ft below msl)	Borehole Anomalies
	1970s Average (mg/l)	1980s Average (mg/l)	1990s Average (mg/l)	Rate of Chloride Ion Change Over Time	1980s Average (gpm)	1990s Average (gpm)		
A-1	17.9	19.1	20.6	0.043	206.3	250.3	-151	
A-2	17.6	20.5	23.2	0.075	198.2	235.8	-51	clay layer, void
A-3	17.3	18.5	18.6	--	208.5	217	-306	
A-4	19.2	24.1	41.6	0.321	185.2	231.8	-289 -159	
A-5	17.5	18.3	21.1	0.058	194.8	234.9	-194	
A-6	17.5	20.7	26.2	0.132	211.4	272.1	-153	
A-7	19.7	22.7	25.2	0.068	194.7	146.5	-48	clay layer, void
A-8	17.1	22.6	20.6	--	199.8	230.6	-173	
A-9	154.5	161.9	182.3	0.311	174.8	214.2	-51	void
A-10	189.8	207.6	286.5	1.24	184.4	210.9	-26	void
A-11	16.9	19.1	18	--	157.7	166.5	-204	void
A-12	18.8	19	19.8	--	215.3	188.1	-252	void

Well	Chloride Ion Concentrations				Production Rate		Termination Depth (ft below msl)	Borehole Anomalies
	1970s Average (mg/l)	1980s Average (mg/l)	1990s Average (mg/l)	Rate of Chloride Ion Change Over Time	1980s Average (gpm)	1990s Average (gpm)		
A-13	269.9	309.8	370.9	1.356	173.4	230.1	(-287) -194	borehole drilled to 287' below msl then plugged with cement to 194' below msl; well cemented from 57' below msl to surface; clay layer
A-14	237.7	288.2	294.8	0.606	179.3	208.5	-52	
A-15	134.8	150.3	147.5	--	170.7	239.7	-52	
A-16	488.1			--				
A-17	275.3	308.9	355.2	1.109	168.4	215.9	-41	
A-18	224.3	288.9	389.9	2.305	162.3	207.3	-55	
A-19	288	275.4	352.9	1.297	119.2	175.3	(-44) -34	void; well rehabilitated in 1975, backfilling to 34' below msl
A-21	204.4	267.4	350.6	1.854	170	199.4	-53	
A-23		21.9	38.8	0.52	235.4	295.6	-51	
A-25		24.5	51.1	1.042	215.9	260.5	-106	
A-26		105.8	82.1	--	108.8	57.6	-47	
A-28		187.2	172	--	189.3	227.4	-46.5	
A-29			65.6	--		339.6	-50.6	
A-30			101.6	--		680.4	-53.6	void
A-31		24	31.7	0.165		256.7		

Well	Chloride Ion Concentrations				Production Rate		Termination Depth (ft below msl)	Borehole Anomalies
	1970s Average	1980s Average	1990s Average	Rate of Chloride Ion Change Over Time	1980s Average	1990s Average		
	(mg/l)	(mg/l)	(mg/l)		(gpm)	(gpm)		
A-32			24.1	--		134.2	-54.5	
NCS 3			148	--		67.3	-47.1	
NCS 8			76.4	-2.91		195.2		
NRMC 1			24.2	0.132		165.5	-79.7	
NRMC 2			70.8	5.233		138.8	-88.8	
NRMC 3			46.7	--		161.7		

Average Chloride Ion Concentrations, Rate of Chloride Ion Change Over Time, Well Termination Depths, and Borehole Anomalies for Yigo Subbasin Wells.

*the rate of chloride change over time is the linear regression equation slope based on the well's entire chloride concentration record

-- indicates that the regression equation did not significantly represent the data at an α level of 0.05

blank entries indicate that data were unavailable or the well was not operating

Well	Chloride Ion Concentrations				Production Rate		Termination Depth	Borehole Anomalies
	1970s Average	1980s Average	1990s Average	Rate of Chloride Ion Change Over Time	1980s Average	1990s Average		
	(mg/l)	(mg/l)	(mg/l)		(gpm)	(gpm)	(ft below msl)	
D-1	55.2	58.2	64	0.136	177.2	212	-36	
D-2	55.3	60.8	62.3	0.089	183.3	199.3	-35	
D-3	35.7	37.1	38.5	--	140.3	161.6	-23	
D-4	38.9	42.2	41.6	--	154.5	151.6	-26	
D-5	59.5	60.1	58.2	--	133.6	173.5	-34	
D-6	51.1	50.7	56.4	0.096	161.1	205.3	-25	
D-7	50.8	50.5	58.6	0.093	147.1	193.6	-49	
D-8	135.7	159.9	225.2	1.054	136.7	192.6	-36	
D-9	112	136.1	151.6	0.53	168.2	189.8	-52	
D-10	38.5	42.2	42.1	--	161.2	195.7	-26	
D-11	81.8	74.9	95.8	0.278	165.1	222.9	-37	
D-12	18.5	32.7	22.8	--	144.9	171.9	-44	
D-13	279.5	252.8	307.9	--	149.4	162.9	-52	rehabilitated in 7/75, bringing the depth to 27' below msl
D-14	33.2	45.6	61.5	0.378	166.6	197.3	-51	

Well	Chloride Ion Concentrations				Production Rate		Termination Depth (ft below msl)	Borehole Anomalies
	1970s Average (mg/l)	1980s Average (mg/l)	1990s Average (mg/l)	Rate of Chloride Ion Change Over Time	1980s Average (gpm)	1990s Average (gpm)		
D-15	80.2	88.2	93.4	0.16	161.2	204.3	-89	
D-16	78.1	81.5	87.6	0.155	189.3	197.4	-59	
D-17	20.5	69.7	179.8	2.615	149	197.6	-49	
D-18		71.8	85.6	0.485	177.6	187.5	-50	
D-19		65.7	64.6	--	204.4	200.1		
D-20		59.5	59	--	223.3	189.9		
D-21		74.6	73.3	--	179.7	155.4		
EX-5A		38.1	44.8	0.314	208.3	214.6		
D-25			32.9	--			-51.5	
D-26			136.6	--			-50.1	
D-27			14.7	--				
D-28			36.6	--			-46.3	
GH-501		80.4	86.9	0.205	168.9	176.9	-92	
M-5	39.3	51.6	54.7	0.218	149.4	163.7	-56	volcanics encountered at 490; passed through fault at 51' below msl; borehole backfilled from 226' to 56' below msl
M-6	64.2	74.2	80.4	0.245	131.7	188.6	-78	possible fracture from 52' to 51' above msl
M-7	33	39.6	41.4	0.106	180.8	172.2	-51	
M-11	720.5			--				

Well	Chloride Ion Concentrations				Production Rate		Termination Depth (ft below msl)	Borehole Anomalies
	1970s Average	1980s Average	1990s Average	Rate of Chloride Ion Change Over Time	1980s Average	1990s Average		
	(mg/l)	(mg/l)	(mg/l)		(gpm)	(gpm)		
M-12	64.8	79.4	83.9	0.29	105.4	103.8	-108	
M-14	35.1	38.3	51.7	0.254	176.3	225.1	-40	
M-15		45.5	47.9	--	174.8	190.2	-50	
M-17A		80	72.4	--		198.6	-51.5	
M-17B		54	61.5	--		288.2	-41.3	possible void at 428' above msl; void at 140.7' and 190.7' above msl
M-18		64	56.6	--		371.6	-42.1	
M-20A			67.9	-3.647		257.8	-21.4	
M-21			63.7	--			-39.5	
Y-1	18.7	22.5	23.9	0.065	142.2	134.7	-35	
Y-2	18.8	23.5	25	0.075	158.3	157	-52	
Y-3	17.6	20.9	22.6	0.069	118	154.5	-50	
Y-4	20.7	25.2	24	0.109	127.1	141.4	-47	
Y-4A			29.8	--		200.9		
Y-5	32.2	37.3	45.4	0.196	150.1	147.2	-47	
Y-6		21.6	23.5	--	140.9	157.9	-50	
Y-7		22.5	23.3	--	361.2	339.3	-50	
Y-9		21	22.3	0.085	422	317.9	-49.5	
Y-10		26.3	36.4	--		181.7	-52.2	
Y-12			52.5	--		280.3		

Well	Chloride Ion Concentrations				Production Rate		Termination Depth (ft below msl)	Borehole Anomalies
	1970s Average (mg/l)	1980s Average (mg/l)	1990s Average (mg/l)	Rate of Chloride Ion Change Over Time	1980s Average (gpm)	1990s Average (gpm)		
Y-14			44	--		250	-38.6	
Y-18			16.8	--			-47	
Y-19			17.2	--			-50	void from 93' above msl to well bottom
Y-20			16.8	--			-50	void from 221' above msl to well bottom

Average Chloride Ion Concentrations, Rate of Chloride Ion Change Over Time, Well Termination Depths, and Borehole Anomalies for Finegayan Subbasin Wells.

*the rate of chloride change over time is the linear regression equation slope based on the well’s entire chloride concentration record

“--“ indicates that the regression equation did not significantly represent the data at an α level of 0.05

blank entries indicate that data were unavailable or the well was not operating

Well	Chloride Ion Concentrations				Production Rate		Termination Depth	Borehole Anomalies
	1970s Average	1980s Average	1990s Average	Rate of Chloride Ion Change Over Time	1980s Average	1990s Average		
	(mg/l)	(mg/l)	(mg/l)		(gpm)	(gpm)	(ft below msl)	
AG-2	18	18.2	22.3	0.074	146.4	111.3	-174	
D-22A			32.5	--		111.8		
D-24			40.6	--		116.5	-163.7	
F-1	72.4	91.4	98.8	0.405	159	141.3	-35	
F-2	102.8	111.7	117.2	0.192	167.4	119.5	-38	
F-3	92.4	105.3	107.1	--	117	146.6	-36	
F-4	79.9	148.6	164.9	1.073	137.5	132.1	-35	
F-5	51.2	67.3	85.6	0.503	132.6	154.1	-33	
F-6	123.4	181.2	202.9	1.006	124.2	159	-23	
F-7	53.3	69.6	83.9	0.41	128.5	175.5	-21	
F-8	17.3	20.7	24.9	0.101	134.7	146.9	-18	
F-9	72.6	64.6	59.5	--	163.4	138.2	-53	
F-10	146.2	168.3	189.6	0.509	165.4	146.9	-47	
F-11	109.5	111.9	120.9	0.339	154.9	146.9	-48	

Well	Chloride Ion Concentrations				Production Rate		Termination Depth (ft below msl)	Borehole Anomalies
	1970s Average	1980s Average	1990s Average	Rate of Chloride Ion Change Over Time	1980s Average	1990s Average		
	(mg/l)	(mg/l)	(mg/l)		(gpm)	(gpm)		
F-12			25.2	0.603		142.2		
F-13			194.9	--		222.6		
F-15			56.5	--		357	-74.5	
F-16			21.3	--		159.6		
F-17			18.4	--		273	-61.7	
F-18			18	--		192.4	-61.1	
F-19			122.5	26.967			-51.5	
F-20			139	--				
H-1	77	111.4	139.6	0.715	178.8	246.8	-19	
HGC-2			23	--		394.4	void at 97' below surface	
NCS 2			127.2	-1.791		198.5	-46.3	
NCS 5			218.8	-4.652		86.7	-79.4	
NCS 6			53.7	-0.61		179.3		
NCS 7			36.9	--		178.9		
NCS 9A			89.4	--		208.9		
NCS A			232.1	--		115.4	-34.1	
NCS B			105.4	--		142.5	-30.1	

Average Chloride Ion Concentrations, Rate Of Chloride Ion Change Over Time, Well Termination Depths, And Borehole Anomalies For Mangilao Subbasin Wells

*the rate of chloride change over time is the linear regression equation slope based on the well’s entire chloride concentration record

-- indicates that the regression equation did not significantly represent the data at an α level of 0.05

blank entries indicate that data were unavailable or the well was not operating

Well	Chloride Ion Concentrations				Production Rate		Termination Depth (ft below msl)	Borehole Anomalies
	1970s Average (mg/l)	1980s Average (mg/l)	1990s Average (mg/l)	Rate of Chloride Ion Change Over Time* (mg/l)	1980s Average (gpm)	1990s Average (gpm)		
EX-11		37.7	46.9	0.272	183.9	182.7		
M-1	142.5	169.3	183	0.449	156.8	126.5	-54	
M-2	76.6	81.8	106.7	0.395	145.6	179.1	-57	
M-3	25.8	25.1	28.8	0.044	207.2	192.5	-53	
M-4	22.1	21.2	27.3	0.068	154.3	159.7	-50	
M-8	21.4	22.7	25.8	0.063	152.3	168.2	-60	void
M-9	196.4	231.5	163.3	-0.503	156.3	156.2	-51	void; volcanics encountered at 33' above msl
M-16B		35.6	34.3	--	130.9	207.5	-45.8	